

Pad Pilot

Part number: 90-60-545 Pad Pilot White
90-60-546 Pad Pilot Carbon



USER MANUAL & INSTALLATION SHEET

V1.1

1	Introduction.....	3
2	Operation.....	3
2.1	Description of the control keys	3
3	Settings of the <i>Pad Pilot</i>	5
3.1	Set up an address for the <i>Pad Pilot</i>	5
3.2	Key sound	5
4	Use in a TOPLINE Bus.....	6
4.1	Selection of a display.....	6
4.2	Autopilot ON / OFF	7
4.3	Course to steer	7
5	Installation	8
5.1	<i>Pad Pilot</i> packing list	8
5.2	Wiring the <i>Pad Pilot</i>	8
5.3	Mounting the <i>Padpilot</i>	9
6	Specifications of the <i>PAD PILOT</i>	10
7	Firmware evolution for the <i>pad pilot</i>	11

1 INTRODUCTION

The **Pad Pilot** controls displays and manages the autopilot.

2 OPERATION

The **Pad Pilot** is given a node address, like a display. When the **Pad Pilot** is powered for the first time, the default address is 0 (factory setting). It will be necessary to define a node address for the Pad Pilot to be recognised and to operate on the Toplevel Bus.
(Refer to 3.1)

2.1 Description of the control keys

The **Pad Pilot** has 10 keys. They are used to control the display, to access the menus and to manage the Autopilot.



- **RED LED**

Led indicating the current mode for the *Pad Pilot* (display selection mode, set-up mode)

Flashes at each press.

- **PAGE** 

Use this key to navigate in various displays of the Toplevel range. Press and hold to access the display selection mode.

This key is also used to access the displays' menus, to scroll the pages and for the "back/return" function.

- **OK** 

This key is used to confirm a selection.

- **NAVIGATOR** 

Use the left and right arrows to select the display. It is also used to navigate in the menus and pages of the selected display.

- **AUTO** 

This key is used to engage the autopilot.

- **STOP** 

This key is used to disengage the autopilot.

- **-1, +1, -10, +10** 

Pressing on one of these keys modifies the course to steer by step of 1° or 10°.

- **MOB** 

Press and hold this key to trigger a Man Over Board function on the Toplevel bus.



3 SETTINGS OF THE *PAD PILOT*

3.1 Set up an address for the *Pad Pilot*



When the *Pad Pilot* is powered for the first time, the default address is 0, the LED flashes once per second, waiting for the operational node address. Press  to allocate an address.

If the *Pad Pilot* already has an address, there are two possibilities:



- You wish to allocate a new address:

Press  +  simultaneously until you hear an audible signal (3 seconds) and the LED flashes once per second. You've accessed the setup mode. To allocate a new address, press .

- You wish to set reset the default address (0):

To do this, press  +  simultaneously during 3 seconds, until you hear an audible signal and the LED flashes once per second. The address 0 is allocated to the *Pad Pilot* by pressing . This restores the setup as it was when the device was powered for the first time.

3.2 Key sound

Every time you press on a key on *Pad Pilot*, this generates a sound. This sound can be disabled by entering the setup mode with  +  during 3 seconds until you hear a Beep and then press the right arrow of . Repeat the procedure to activate the key sound.

4 USE IN A TOPLINE BUS







4.1 Selection of a display

To select a display with the *Pad Pilot*, press **PAGE** until the second beep (5 seconds). You've accessed the selection mode. Then press on the left or right arrow to toggle between displays. You may press several times until you find the desired display.





This operation is required on the first use, as by default no display is selected.



- Select the TL25 :

Press on **PAGE** until the second beep, then with  and left and right arrows you can select the TL25. Once the TL25 is selected, the upper line flashes. Press  to confirm this display is selected. Then you can modify the upper line using up and down arrows of . To change line, use **PAGE**. Press and long hold  to access the sub-channel. Press  to change the sub-channel. Press and hold long  to exit.



- Selecting Multigraphic:

Press **PAGE** until you hear a second beep and choose a display using the left and right arrows of : Once Multigraphic has been selected, a remote control (version 2.3) or a yellow box (version 2.4) appears, then press  to confirm. The keypad works the same way as the one on the Multigraphic. Refer to the manual of Multigraphic V2.4 or newer.

- Selecting Multidisplay:



Press **PAGE** until you hear a second beep and choose a display using the left and right arrows of : Once the Multidisplay has been selected, a yellow box appears and press  to confirm. Refer to the Multidisplay manual.

4.2 Autopilot ON / OFF

- To engage the autopilot, press 
- To disengage the autopilot, press 

4.3 Course to steer

Pressing on any of the four keys  alters the course to steer.

A long press on  or  (+10°) triggers an automatic tack.

5 INSTALLATION



WARNING

Turn the power supply Off before doing any work on the TOPLINE Bus.

5.1 *Pad Pilot* packing list



- A **Pad Pilot** with a six metres cable.
- A protection cover.
- A Fixamo M14.
- A plastic M14 nut.

5.2 *Wiring the Pad Pilot*

- Connect the bus cable to a Topline junction box as follow:
 - White wire on "**+12 V white**" or "**+/white**"
 - Shield on "**GND**" or "**-/nu**"
 - Black on "**Data black**" or "**D/black**"

5.3 Mounting the *Padpilot*

There are several ways to mount the *Pad Pilot*.



A 18 mm diameter hole is required to allow the cable running as well as the mounting kit.



If the supporting surface is between 1 and 3mm: Screw the plastic nut by hand.



If the supporting surface is between 3.1 and 40 mm: Screw by hand the Fixamo to the unit and then the plastic nut.

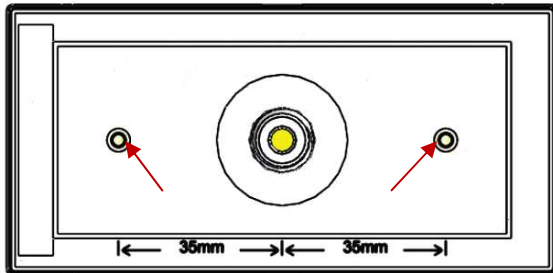

Alternatively, you can use the two inserts at the back of the Pad, and screw two M3 screws.

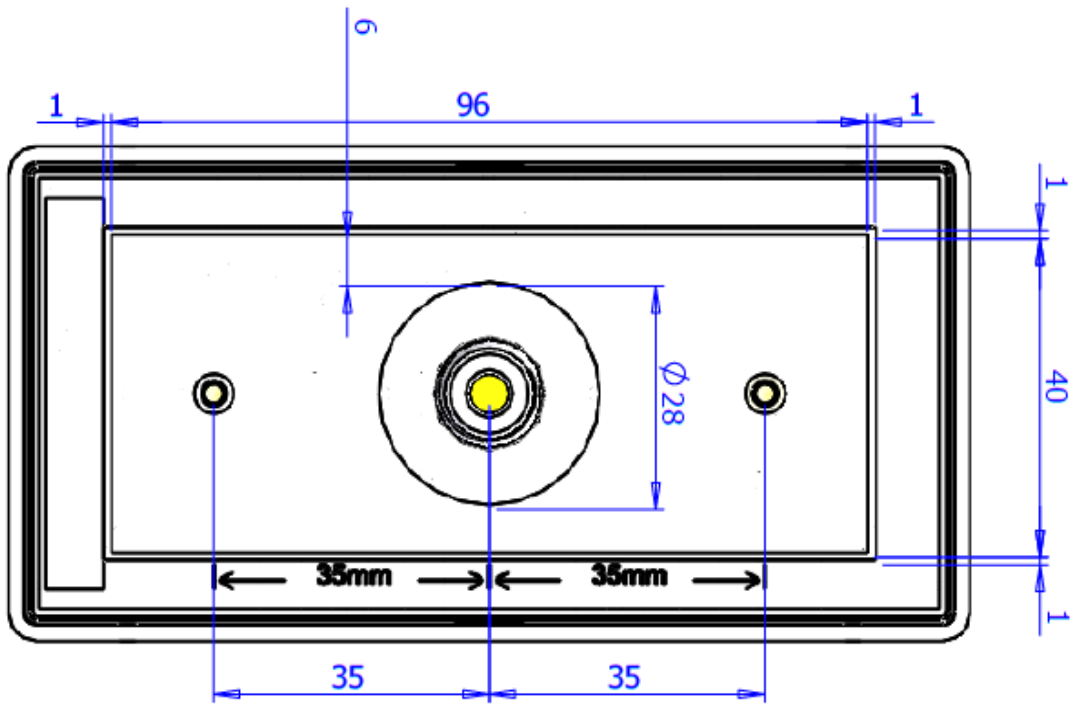

DRILLING TEMPLATE

6 SPECIFICATIONS OF THE PAD PILOT

Parameter	Value
Dimensions	With protection cover (mm): 122 x 62 x 27 (Length x Width x Depth) Without protection cover (mm): 115 x 58 x 23 (Length x Width x Depth)
Mounting kit	- Hand-screw nut M14 (part Nr: 30-95-032) - Fixamo M14 (part Nr: 30-95-031)
Weight	350g with 6m of cable (32g/m) and protection cover
Power supply	8V – 32V DC
Operational consumption @ 12 V	< 30mA
Topline bus power cable	Ø5.5mm, 2 wires + ground, length 6m
Operational temperature	-10°C / 50°C
Storage temperature	-20°C / 60°C
Protection rate	IP7 waterproof to water projections

7 FIRMWARE EVOLUTION FOR THE *PAD PILOT*

REV	Date	Information
V1.0	21/06/2018	- Original version
V1.1	08/11/2018	- Bug correction for long auto shortcut. - Possibility to acknowledge the TOPLINE Bus audible alarms. - Compatibility with HR and Regatta processors.