

Multifonction

Gyropilot Graphic

Command interface of the *GYROPILOT 2*

Product reference: 90-60-348 white / 90-60-352 carbon



USER GUIDE

and

INSTALLATION GUIDE

REV 2

nke - Sailing competition

Z.I. Kerandré – Rue Gutenberg – 56700 HENNEBONT- FRANCE
<http://www.nke.fr> – N° indigo 0 892 680 656 : 0,34€/min.

TABLE OF CONTENT

1. USING THE GYROPILOT GRAPHIC IN PILOTE MODE	4
1.1 PRESENTATION	4
1.2 GENERAL OPERATION OF THE <i>GYROPILOT GRAPHIC</i>	6
1.3 FUNCTIONS OF THE KEYS OF <i>GYROPILOT GRAPHIC</i>	7
1.4 FIRST STARTUP OF THE PILOT	8
1.5 DESCRIPTION OF THE FIVE OPERATING MODES	10
1.6 PILOT SETTING MENU : OPTIMISING THE PERFORMANCES OF THE PILOT.....	15
1.7 PROTECT YOUR SETTINGS WITH A PROPRIETARY CODE	19
1.8 PERFORMING A TACKING OR JIBING MANOEUVRE UNDER PILOT CONTROL	20
1.9 LIGHTING SETTING.....	20
1.10 SETTING THE ALARMS OF THE PILOT	22
1.11 OPERATION OF THE <i>GYROPILOT</i> IN DEGRADED MODE	23
1.12 « MAN OVER BOARD » FUNCTION.....	23
1.13 POWER CONSUMPTION OF THE GYROPILOT.....	24
2. USING THE GYROPILOT GRAPHIC IN MULTIFUNCTION DISPLAY MODE	25
2.1 CONFIGURE YOUR DISPLAY FOR THE DISPLAY OF 1, 2, 3 OR 4 CHANNELS.....	25
2.2 LIST OF CHANNELS CREATED	26
2.3 CONFIGURING THE DISPLAY OF THE CHANNELS	27
2.4 DISPLAY CONFIGURATIONS BACKUP AND RESTORE	27
2.5 WHAT IS A SUB-CHANNEL ?	28
2.6 ALARMS SETTING FOR THE CHANNELS OF TOPLINE INSTRUMENTS	28
2.7 FILTERING OF THE CHANNELS	30
2.8 CHOICE OF THE UNIT	30
2.9 ZERO SETTING OF THE DAILY LOG	31
2.10 CHOICE OF LANGUAGES	32
2.11 USE OF THE CHRONOMETER.....	32
2.12 NMEA LINK	33
2.13 THE NMEA CONSOLE : A TOOL TO VISUALISE THE NMEA FRAMES	35
2.14 TECHNICAL SPECIFICATIONS.....	35
2.15 VERSION OF THE <i>GYROPILOT GRAPHIC</i>	35
2.16 DIAGNOSTIC FOR 1 ST LEVEL TROUBLES SHOOTING.....	36
2.17 INITIALISATION OF THE <i>GYROPILOT GRAPHIC</i> : SEE CHAPTER 4.6.....	36
3. SENSOR CALIBRATION	37
3.1 SETTING PROCEDURE OF THE CALIBRATION COEFFICIENT	37
3.2 OFFSET SETTING.....	38
3.3 AUTOCOMPENSATION OF THE FLUXGATE COMPASS	38
3.4 SETTING THE DEPTH-FINDER BLANKING	39
4. CALIBRATION UTILITIES	40
4.1 AUTOMATIC CALIBRATION OF BOAT SPEED	40
4.2 CALIBRATION OF THE NKE COMPASS BASED ON THE CORRECTION TABLE.	42
4.3 CALIBRATION OF APPARENT WIND ANGLE.....	46
5. INSTALLATION	47

5.1	PACKING LIST.....	48
5.2	LIST OF ACCESSORIES	48
5.3	INSTALLATION PRECAUTIONS	48
5.4	WALL MOUNTING	48
5.5	CONNECTION TO THE <i>TOPLINE BUS</i> AND TO THE <i>NMEA BUS</i>	50
5.6	INITIALISATION OF THE <i>GYROPILOT GRAPHIC</i>	51
5.7	INITIALISATION OF THE PILOT INSTALLATION	52

1. USING THE *GYROPILOT GRAPHIC* IN PILOTE MODE

1.1 Presentation

We thank you for your confidence in the *nke* trademark, by choosing the *Gyropilot Graphic*. You have just acquired a pilot command, identical to that which is fitted on sailing boats of ocean skippers: Vendée Globe, Route du Rhum and Transat the single handed raicing.

The *nke* pilot includes:

- the *Gyropilot Graphic*, it is the user interface. It allows to control the pilot and adjust the settings,
- the *Gyropilot 2 calculator*, which is the brain of the pilot,
- the hydraulic unit or electrical unit, which provides the power to actuate the boat's rudder,
- the sensors, which provide the information on the boat's behaviour and external parameters. Depending on the level of equipment of your installation, you will find: the *fluxgate* compass, the *speedometer*, a *rudder angle* sensor, a *masthead unit* (optional for wind mode) and the gyro sensor (integrated in the calculator).

This user and installation guide includes the information that will allow you to:

- to be able to set up the *Gyropilot 2 computer* and the sensors,
- To get well accustomed to your *Gyropilot Graphic*, and to master all its function,
- carry out the installation,
- achieve optimum performances with your automatic pilot and your boat.

The *Gyropilot Graphic* is also a *Multifunction* display. Its graphic screen offers a wide range of display options:

- A detailed representation of the *Gyropilot 2* control parameters.
- A *Multifunction* that is easily configurable, for screen display of 1, 2, 3 or 4 channels.
- A pull-down menu, which indicates the settings and configurations in full.

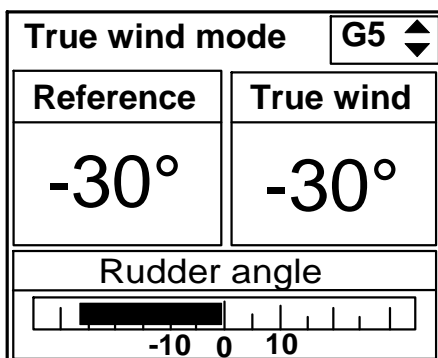

PILOT page

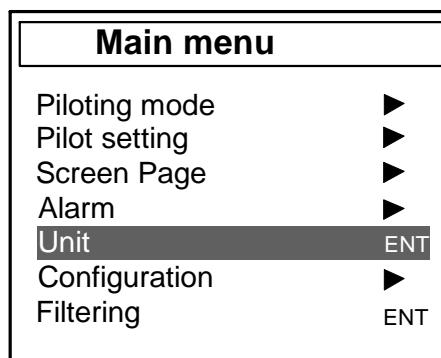

MENU page

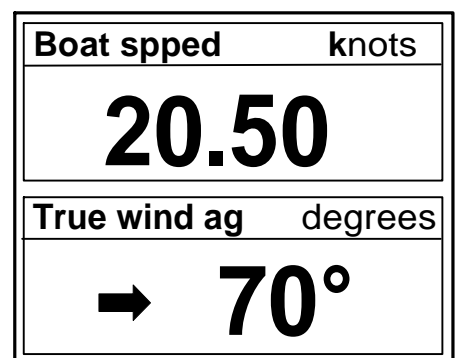

Multifunction page

Architecture of the installation

The presence of the equipment in the following diagram is for information only, and does not represent the equipment of your installation.

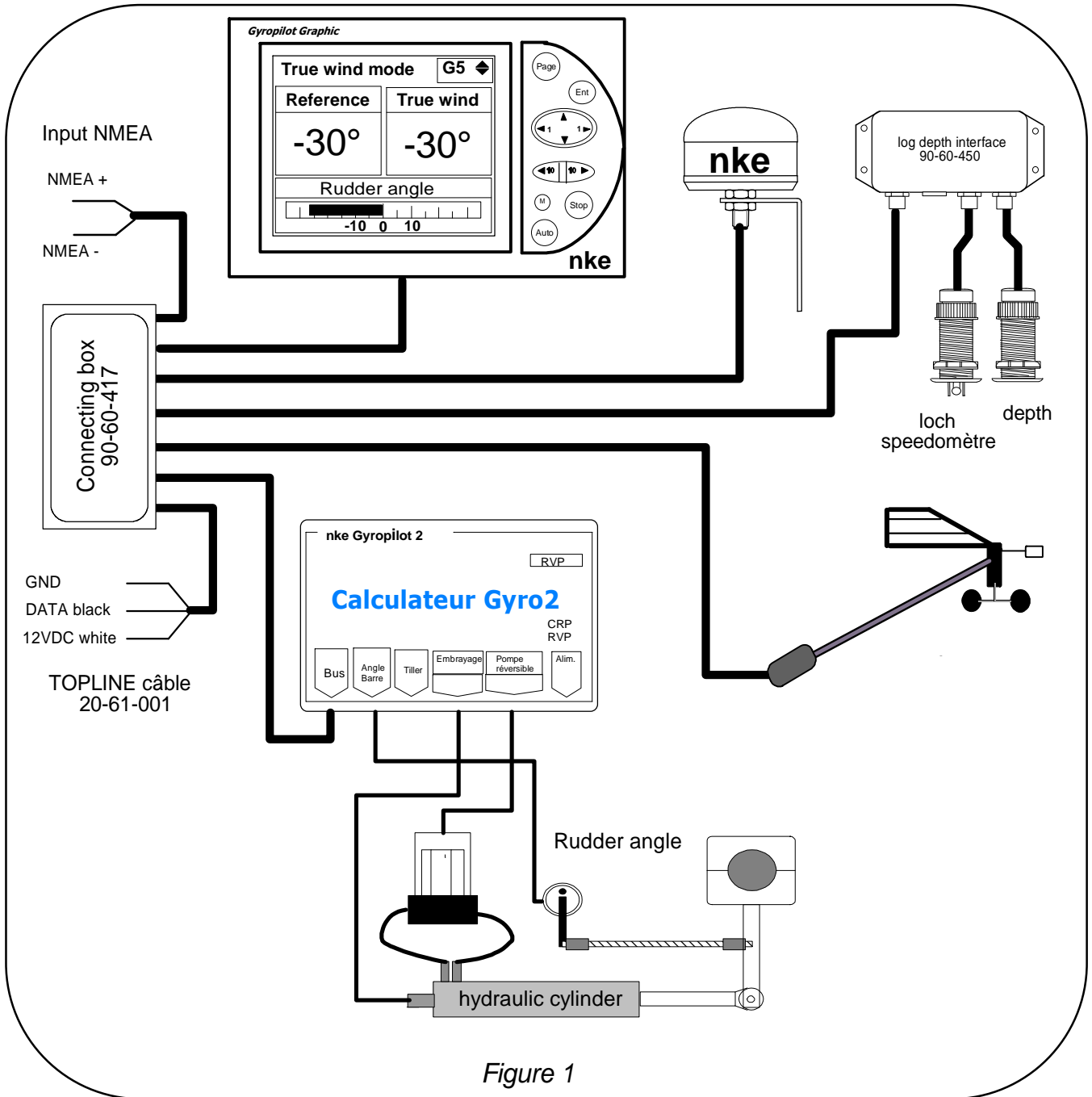

Figure 1

1.2 General operation of the *Gyropilot Graphic*

The *Gyropilot Graphic* is an remote designed to control boats. At the helm, the performances of the *Gyropilot* are excellent at any sailing speed. It allows to assist the helmsman effectively, but must not be used as the primary means to navigate.

As soon as the helmsman activates the pilot, the *Gyropilot 2 computer* stores the current value of the channel concerned: *magnetic heading*, *wind angle* or GPS course. This value becomes the *set point*.

Then, the *computer* integrates the data transmitted by the sensors and performs rudder corrections according to two criteria:

- the cross-track error compared to the set point, which is provided by the *fluxgate* compass (*compass mode*) or by the *masthead unit* (*wind mode*).
- the speed of rotation of the boat, which is provided by the gyro sensor. This rotation is caused by the action of the rudder, the wind or the waves.

Hence the correction value is proportional to:

- the cross-track error measured,
- the gain value,
- and inversely proportional to the speed of the boat.

CAUTION:

Never leave the helm without supervision. The helmsman must remain watchful and attentive to the sudden events that can occur while the autopilot is operating. He must be ready to retake control of the rudder at any moment.

1.3 Functions of the keys of *Gyropilot Graphic*

☛ key

Pressing this key allows you to select the display of the *pilot* page, the *Multifunction display* page or the *menu* page.

It also allows to leave the setting menus, without performing a backup.

☛ key

Press this key to validate your modifications. It also allows to enter a setting menu.

☛ The browser

In the *pilot page*:

- the ◀1 and 1▶ keys allow to increase or decrease the setting by 1°
- the ▲ and ▼ keys allow to adjust the *Gyropilot* GAIN.

In the *Multifunction display* page :

- the ▲ and ▼ keys allow to select the display row you wish to modify.
- the ◀1 and 1▶ keys allow to change the channel on display.

In the *menus* page:

- the ◀1 and 1▶ keys allow to enter or exit a menu.
- the ▲ and ▼ keys allow to select a menu or parameter in a list.

☛ key

Press this key to engage the *Gyropilot*.

☛ key

Press this key to disengage the *Gyropilot*.

☛ key (red colour)

This key allows to decrease the set point by 10° on port side.

☛ key (green colour)

This key allows to increase the set point by 10° on starboard side.

☛ Man Over Board key

Press this key for 5 seconds, and the « Man over board » function is enabled.

1.4 First startup of the pilot

This first part of the guide explains how to use the **Gyropilot Graphic**, on the basis that it is installed and initialised. If that is not the case please refer to the installation chapter of this guide.

The **Gyropilot Graphic**, delivered with a factory setup configuration, will achieve a good level of performance on the majority of boats. This setup configuration is called « **initial setup** », and is saved in the **Config restore** menu. You can restore this initial setup at all times (see chapter 1.7.7).

Powering up or powering down your installation is done using the auxiliary switch of the electric switchboard of your boat. Your installation must comprise two separate 12V power supplies: one for power to the hydraulic pump and to the computer and the other for the **Gyropilot Graphic**, the **TOPLINE** bus and the sensors. If it is not possible to have 2 batteries pack you must set up a converter 12V/12V.

CAUTION: It is imperative to start the first power supply before that of the **TOPLINE** bus.

1.4.1 Procedure for the use of the **Gyropilot in compass mode**

- reach the open sea with your boat before engaging your pilot,
- steer your boat and maintain the heading you wish to follow : the rudder must be in line with the axis of the boat,
- when you follow the right heading, press the **Auto** key to engage the **Gyropilot**.
- the pilot then takes the current heading as **set point**. The **Gyropilot** is then engaged and steers the boat.
- to disengage the **Gyropilot**, retake hold of the rudder and press the **stop** key.

The **Pilot Page** below is displayed on the **Gyropilot Graphic** screen.

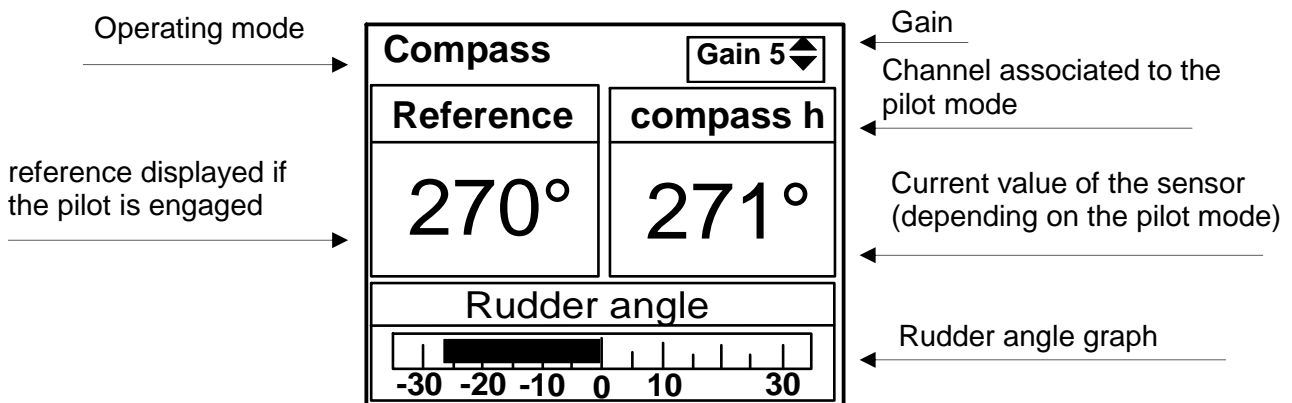

Note that when the pilot is engaged, the set point is displayed in the **reference** window. When the pilot is disengaged, three dashes «---» are displayed in this window.

CAUTION:





The **Auto** key allows to engage the automatic pilot, i.e. to activate it.

The **Stop** key allows to disengage the automatic pilot, i.e. to deactivate it.

Before cutting the power supply of your installation, disengage the pilot.

1.4.2 Adjusting the pilot setting

If you wish to modify the heading or the speed the pilot is set to follow, you can adjust the **Gyropilot** set point at any time, without disengaging the pilot. Use the keys below to adjust the set point

- The  key allows to decrease the set point by 10° on port side.
- The  key allows to increase the set point by 10° on starboard side.
- The  and  keys allow to increase or decrease the setting by 1°.

1.4.3 Setting the pilot gain



The **Gain** setting is essential for the good operation of the pilot. This parameter acts on the reactivity of the rudder and the amount of rudder to provide. The gain calculation takes into account the boat speed and is inversely proportional to that speed. Indeed, the higher the boat speed, the lower the rudder angle.

We recommend that you set the **Gain** value such as to adapt to the performances of the **Gyropilot**, according to the sailing conditions and the speed of the boat.

The **Gain** can be set between **1** and **9**, here are some examples of setting :

- At close-haul, calm sea, constant wind: Gain = from 1 to 5.
- At close-haul, rough sea, variable wind: Gain = 4 to 8.
- Beam wind, rolling sea: Gain = 5 to 9.

☛ Keys for fast access to GAIN setting

- Display the **Pilot Page**,
- using the  and  keys, set the new **Gain** value,
- press the  key to validate your setting : the new **Gain** is saved to the memory.

☛ **Useful tip:** Before engaging the pilot, set the gain to **7**. Steer your boat and maintain the heading you wish to follow. Then, position the rudder in the centre, at the exact time when you press the **AUTO** key. The pilot will thus take control of the rudder in the best conditions. Then, reduce the gain to optimise the consumption.

IMPORTANT:

Le **Gyropilot** uses very little energy (a few tens of milliamps) when the pilot is disengaged. Hence when you are sailing and the pilot is disengaged, it is not necessary to cut off the power supply of the pilot to save energy.

1.5 Description of the five operating modes

The **Gyropilot Graphic** has five operating modes: the **compass** mode, the **apparent wind** mode, the **true wind** mode (in option) , the **GPS** mode and the **rudder** mode. The choice of one of these four modes allows you, depending on the sailing conditions, to make the most of the performances of the **nke** pilot.

These five modes will be accessible on the **Gyropilot Graphic** depending on the level of sensor equipment of your installation:

- The **compass mode** requires a speedometer log sensor and a compass sensor.
- The **apparent wind** mode requires a speedometer log sensor, a compass sensor and an masthead unit.
- The **true wind** mode requires a speedometer log sensor, a compass sensor, a masthead unit, and a « true wind » software option.
- The **GPS** mode requires a speedometer log sensor, a compass sensor, as well as a GPS, or any other instrument providing GPS NMEA frames. The latter must be connected to the NMEA input of your **nke** installation.
- **Rudder** mode: no sensor required.

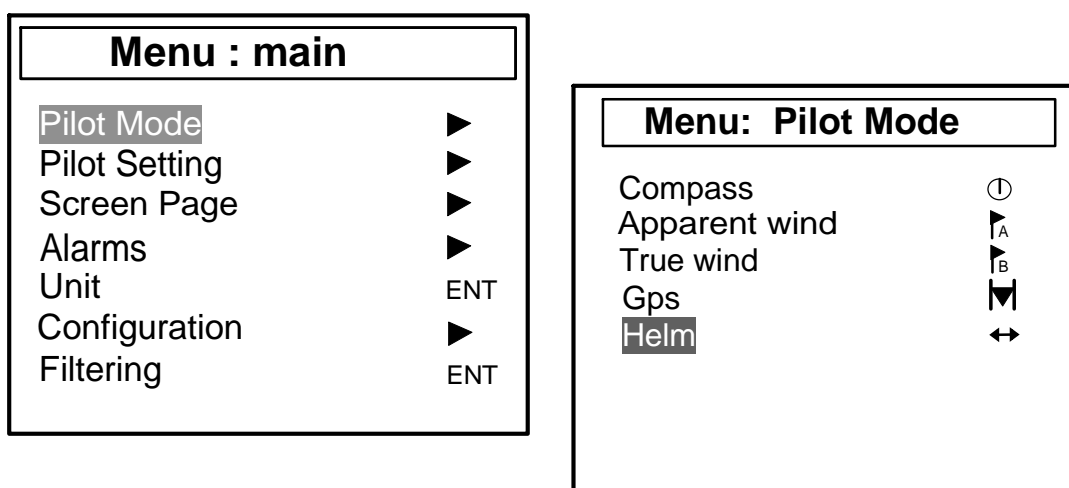

1.5.1 Selecting the pilot mode

- your pilot is disengaged,
- press the **Page** key to select the **main** menu,
- using the browser , enter the **Pilot Mode** menu,
- select the **Pilot mode** of your choice,
- press the **Ent** key to validate your selection : the new **pilot mode** is saved to the memory.

CAUTION:

If you are sailing in **wind mode** and you wish to change sail, you must switch to **compass mode** before performing the manoeuvre.

More generally, a sudden ship imbalance can cause the pilot to operate abnormally for a short period of time. For safety reasons, stay alert.

☛ Keys for fast access to the *pilot mode*

Your pilot is disengaged:

- display the pilot page,
- press the **Page** key, until the **Pilot Mode** is activated,
- using the ▲ and ▼ keys, select the **Pilot Mode** of your choice,
- press the **Ent** key to validate your selection.

Your pilot is engaged:

- display the pilot page,
- press the **Page** key, until the **pilot mode** is activated,
- using the ▲ and ▼ keys, select the **Pilot mode** of your choice,
- press the **Auto** key to validate your selection.

1.5.2 Operation in compass mode

In compass mode, the **Gyropilot** steers the boat following the **magnetic heading** provided by the **fluxgate compass** of your **Topline** installation.

The **compass mode** screen below is displayed:

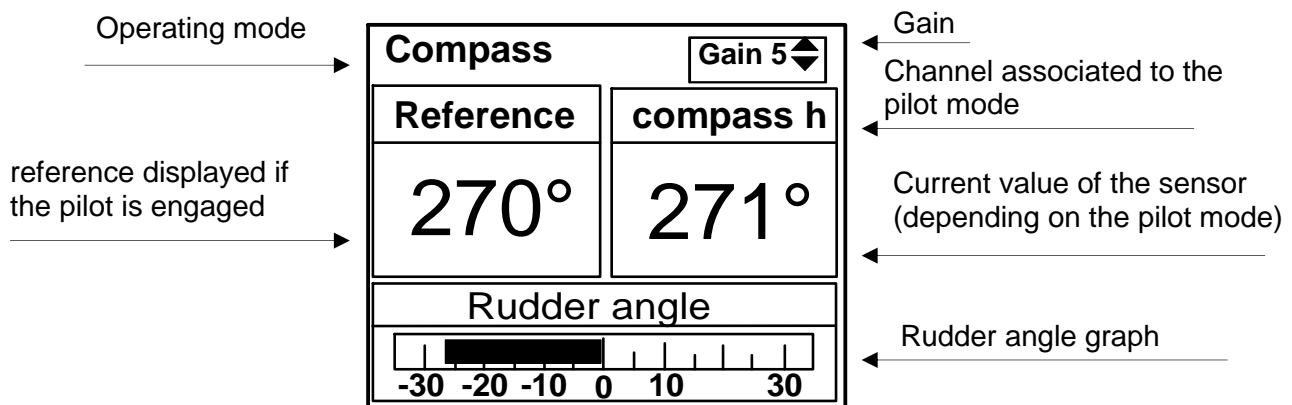

- The **Reference** window that indicates the reference heading to attain. This window displays three dashes « --- » when the pilot is disengaged.
- The **Magnetic Heading (compass h)** that indicates the current heading followed by the boat ; this is the **Topline magnetic heading** channel,
- The pilot gain window is common to the four modes.
- The window of instant angle of rudder position is common to the **compass, apparent wind, true wind** and **rudder** modes.

1.5.3 Operation in apparent wind mode

In apparent wind mode, the **Gyropilot** steers the boat according to the **apparent wind** angle provided by the masthead unit of your **Topline** installation.

The **apparent wind mode** screen below is displayed:

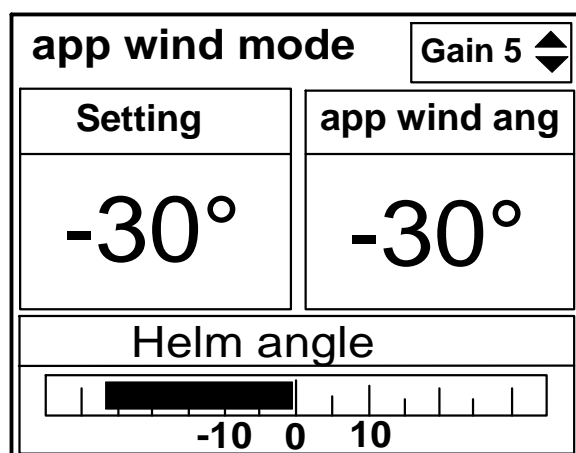

- The **Set point** window that indicates the reference angle of apparent wind to attain. This window displays three dashes « --- » when the pilot is disengaged.
- The window **app wind ang** : indicates the current angle of apparent wind followed by the boat ; this is the **Topline apparent wind** channel,
- The pilot gain window is common to the four modes.
- The window of instant angle of rudder position is common to the **compass, apparent wind, true wind** and **rudder** modes.

1.5.4 Operation in true wind mode

In **true wind** mode, the **Gyropilot** steers the boat according to the **true wind** angle provided by the computer of your **Topline** installation.

Why the true wind mode?

The **true wind** mode is more particularly effective before the wind with a strong swell: it is under these sailing conditions that the **Gyropilot nke** demonstrates its capabilities. Before the wind and in the swell, if you use the **apparent wind** mode, you will notice the following:

- When the boat goes down the wave, the apparent wind speed increases, the apparent wind angle decreases and thus the wind hauls forward. Action of the pilot: it makes the boat fall off.
- When the boat climbs the wave, the apparent wind speed decreases, the apparent wind angle increases and thus the wind veers aft. Action of the pilot, it makes the boat luff.

You can now appreciate that the **apparent wind** mode in the swell does not allow to follow a perfect heading and it is then necessary to switch to compass mode to go down the wave in a straight line.

The true wind mode allows to go down the wave in a straight line and to maintain the optimum angle of descent. The true wind angle does not change according to the speed of the boat. In the single handed sailing, it is more effective to leave the helm with the pilot and to adjust the sails, but be careful with the consumption.

The **true wind mode** screen below is displayed:

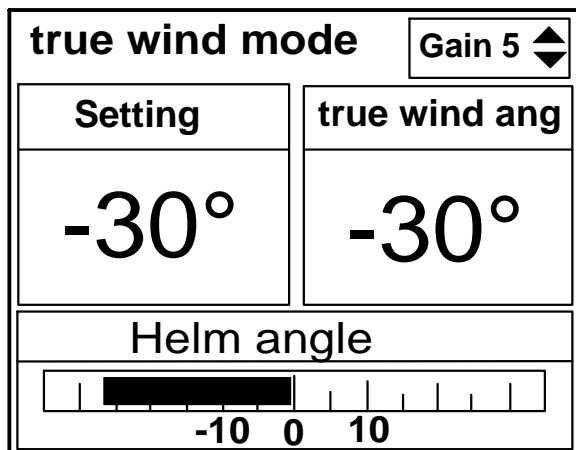

- The **Set point** window that indicates the reference true wind angle to attain. This window displays three dashes « --- » when the pilot is disengaged.
- The **Tr wind ang** window : indicates the true wind angle followed by the boat ; It is the calculated channel **Topline true wind angle**,
- The pilot gain window is common to the four modes.
- The window of instant angle of rudder position is common to the **compass, apparent wind, true wind** and **rudder** modes.

1.5.4.1 Software option: true wind mode

The **true wind mode** is a software option of the **Gyropilot 2 calculator**. To activate this function, you must enter a code in the configuration menu of the **Gyropilot Graphic**.

To obtain the « true wind option » code, please contact your **nke** distributor. Since this code is unique for each **Gyropilot 2 calculator**, you must communicate the serial number of your instrument to your distributor.

1.5.4.2 Obtaining the serial number of your computer and entering the « True wind option » code

- Using the **Page** key, select the **Main menu** page,
- then using the browser , select **Configuration** then **proprietary code**,
- press the **Ent** key,
- select **options code**, then press the **Ent** key,
- in the window below, the serial number of your **Gyropilot** is displayed,
- communicate this number to your distributor to obtain the « True wind option » code,
- using the browser, enter the four digits of your code,
- press the **Ent** key : the **true wind option** is activated.

Menu: configuration	
◀ Calibration	Ent
◀ Channels masking	Ent
◀ Languages	Ent
◀ Address initialisation	Ent
◀ NMEA initialisation	Ent
◀ NMEA console	Ent
◀ Proprietary code	Ent
◀ Pilot initialisation	Ent

Codes
Proprietary Options

Proprietary code
Gyropilot unlocked
Code : 0 0 0 0

1.5.5 Operation in GPS mode

In **GPS** mode, the **Gyropilot** steers the boat according to a **course** provided by the GPS. For that, a GPS or any other instrument providing GPS NMEA frames must be connected to the NMEA input of your **Topline** installation and we must have a active course. The GPS configured in navigation mode will need to provide the NMEA frames below (see NMEA initialisation chapter):

- **\$xxXTE** : cross-track error
- **\$xxRMB** : XTE, latitude, longitude and distance and heading to destination (DTW and BTW in minimal data).
- **\$xxBWC** : distance and heading to destination (DTW and BTW)

The **GPS mode** screen below is displayed:

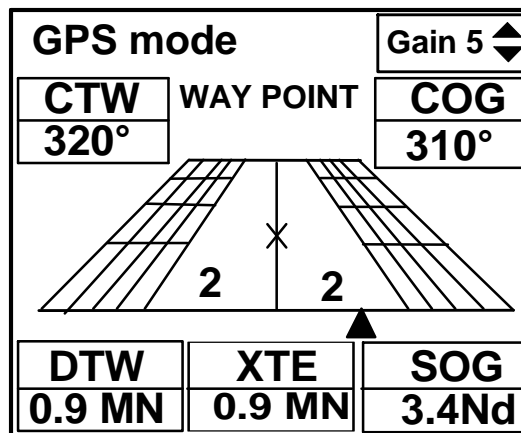

- A graph allows to view the cross-track error, i.e. the XTE.
- The information on **CTW** (Heading towards WayPoint), **COG** (bottom heading in °), **DTW** (distance to WayPoint in Km or Mn), **SOG** (bottom speed in Km/hr or Kt) and **XTE** are displayed.

At the engine, the orientation of the boat and its distance in relation to the course are not important. When pressing the AUTO key, the boat rejoins the course, turning round if necessary. If the cross-track error is too significant (> 0.4 Nautical miles), the boat rejoins the course at a 45°angle.

When the WAYPOINT is reached, the pilot sounds, it maintains the compass heading and exits the GPS mode. The skipper must then check that his course is clear and that the direction to the next WAYPOINT is correct. He then presses the AUTO key once more: this will enable the GPS mode once again, directing the boat towards the next WAYPOINT. The procedure is repeated for each new WAYPOINT.

1.5.6 Operation in rudder mode

The **rudder mode** allows to set an angle of rudder and to lock the rudder at the chosen setting. The angle of rudder can thus be adjusted to a set position, from - 40 to + 40° in relation to the axis of the rudder.

The **rudder mode** screen below is displayed:

In particular, the rudder mode can be used at port to check the operation of the cylinder or very simply to lock the rudder in a set position.

1.6 Pilot setting menu: Optimising the performances of the pilot

The **Gyropilot**, delivered with a factory setup, will achieve good performances on any type of boat. However, you can optimise the performances of the **Gyropilot** by adapting the settings to the specificities of your boat, and to the sea and wind conditions.

In the menu **pilot setup**, the list of setup parameters is available. The menu below indicates the **Initial setup**, which is the default configuration of the pilot (see chapter 1.7 :

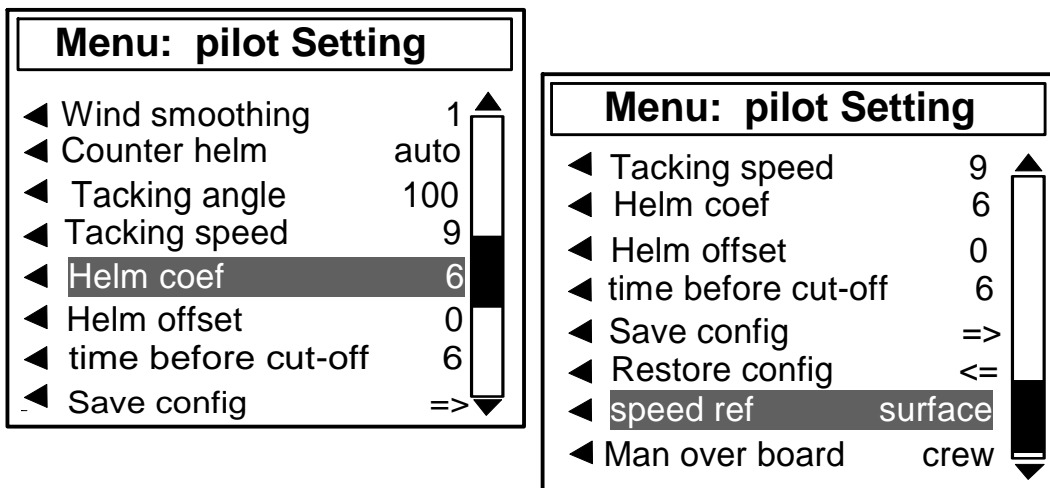

1.6.1 Wind smoothing

The **wind smoothing** parameter corresponds to the damping of the wind value measured by the wind vane. In **wind mode**, this value is taken into account by the calculator. For example, in rough sea when the boat moves significantly, it is interesting to increase the **smoothing**, because the vane of wind sensor, attached at the mast head, is subjected to abrupt movements. Conversely, in calm sea, low **smoothing** will be preferable to obtain a fast response of the pilot. **Smoothing** is adjustable between **1** and **9**. The stronger this value, the longer the damping time in seconds. The default smoothing value is **1**.

The **automatic wind smoothing** is obtained by entering the value **0**. In this case, damping automatically adjusts according to the oscillations of the wind vane. Damping is equal to 0.5 second per degree of oscillation of the wind vane. For example, when the wind vane oscillates by +/-10° then the value of damping is **10** seconds.

Smoothing value	Damping value
L = 0	Automatic
L = 1	1s
L = 2	2 s
L = 3	4s
L = 4	8 s
L = 5	16 s
L = 6	32 s
L = 7	64 s
L = 8	128 s
L = 9	256 s

1.6.2 Counter helm

After steering the boat, to correct the **magnetic heading** or the **wind angle**, you naturally bring the helm back beyond the central position, in order to control the inertia of the boat: it is the **counter helm** this parameter is more or less important, depending on the type of boat and the sailing conditions. The calculation of this parameter is based on the rotation speed of the boat, which is measured by the rate gyro sensor, located in the **Gyropilot** calculator.

When it comes out of the factory, the counter helm is set on **AUTO**. That way, the counter helm adjustment is automatically performed as a function of the gain. The counter helm is adjustable between **1** and **9**. The stronger this value, the larger the angle of counter helm.

Please note that for a gain comprised between 1 and 3, the rate gyro is inactive, and there is no counter rudder. For gain between 4 and 9, the rate gyro is active, and the counter rudder value is automatically adjusted according to the selected gain (if the counter helm is set on AUTO).

1.6.3 Automatic tacking angle and speed

You can set the angle and speed of automatic tacking performed by the **Gyropilot** :

- In compass mode, the value of the tacking angle can be set between 70° and 115° in 5° steps. By default, the value is set at **100°**.
- The speed of rotation during tacking manoeuvres under pilot control can be set between 1 and 32. By default, the value is set at **9**.

1.6.4 Helm coefficient

Principle of operation: the *Gyropilot* computer automatically determines the helm coefficient, and adjusts the angle of helm proportionally to the speed of the boat. The higher the speed, the lower the angle of helm.

However, if this setting is not appropriate it is possible to amplify or to reduce the amplitude of the angle of helm, by modifying the *helm coefficient*. The latter is adjustable between **1** and **53**. The higher this value, the higher the angle of helm, proportionally to the speed of the boat. By default, the *helm coefficient* is set at **6**.

Please note that when the channel *surface speed* is not present on the bus, the *Gyropilot* uses the *bottom speed* channel (if it is present on the bus).

☛ **Useful tip:** to check the effectiveness of your setting, enter an extreme value, for example **50**, and compare the behaviour of your boat, before the setting and after this extreme setting. A difference in the behaviour of the pilot should be observed with the two settings.

1.6.4.1 Degraded mode

If the channels *surface speed* and *bottom speed* are not present on the *TOPLINE* bus, then the *Rudder coefficient* parameter assumes another meaning: it becomes the average speed of the boat. This mode of operation is less efficient, but is used in case the measurement of speed breaks down. In that case, disconnect your depth-log interface from the bus, and restart the installation (the *speed* channel must no longer be present on the bus). Then, enter the average speed of the boat in the *rudder coefficient*.

1.6.5 Rudder offset

This parameter allows to set the middle point of the rudder, from -3° to $+3^{\circ}$ in relation to the axis of the boat. By default, the *rudder offset* is set at **0°**.

1.6.6 Time before cut-off

This time lag is used to force the pilot to keep control of the rudder, in the case of a communication breakdown with the *TOPLINE* bus. The time lag is adjustable between 6 and 60 seconds, and the default value is 6 seconds. By default, the *time before cut-off* is set at **6**.



1.6.7 Configuration backup and restore

You have the option to backup 9 setup configurations of the pilot. For example, you can backup a configuration for speed at close-haul and another for speed before the wind. The **Initial setup** is the default configuration of the pilot: you can restore it at any time.

To save a configuration:

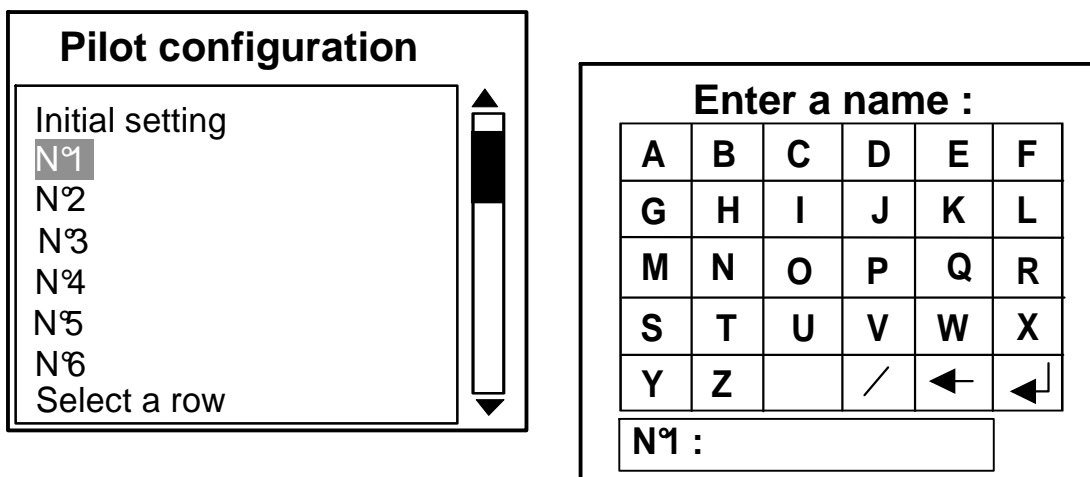
- select the **Save config** menu and press the **Ent** key,



- select the number of the configuration you wish to save.
- using the browser  and the screen keyboard, enter the name of your configuration. Each letter that is part of the name must be validated by pressing the **Ent** key.
- validate the name you have entered by pressing the  key.

1.6.8 Restoring a configuration

- Select the menu **Restore config** and press the **Ent** key,
- select the configuration you wish to restore, then press the **Ent** key.

1.6.9 Speed reference



If your pilot is equipped with the **True Wind** option, this function allows to select the reference speed of the calculator. You can select **bottom speed** or **surface speed**. It is only to calculate at each movement the helm angle in accordance with the speed.

1.7 Protect your settings with a proprietary code

To prevent a user from modifying your pilot settings and your sensor calibrations, the **Gyropilot Graphic** offers the option to protect your configuration with a proprietary code. The **Gyropilot Graphic** is delivered with no security code and thus all the settings are accessible.

Note that this function is only available on the **Gyropilot Graphic**, and that the settings can be modified from another **multifunction** display connected to the bus.

1.7.1 Enter your security code

- Using the **Page** key, select the **Main menu** page,
- then using the browser , select **Configuration** then **proprietary code**,
- press the **Ent** key,
- select **proprietary**, then press the **Ent** key,
- using the browser , enter the four digits of your security code,
- press the **Ent** key and select **yes** : the **Gyropilot** is then locked.

In the setting menus, a symbol representing a padlock  is then displayed in front of the settings which are locked.

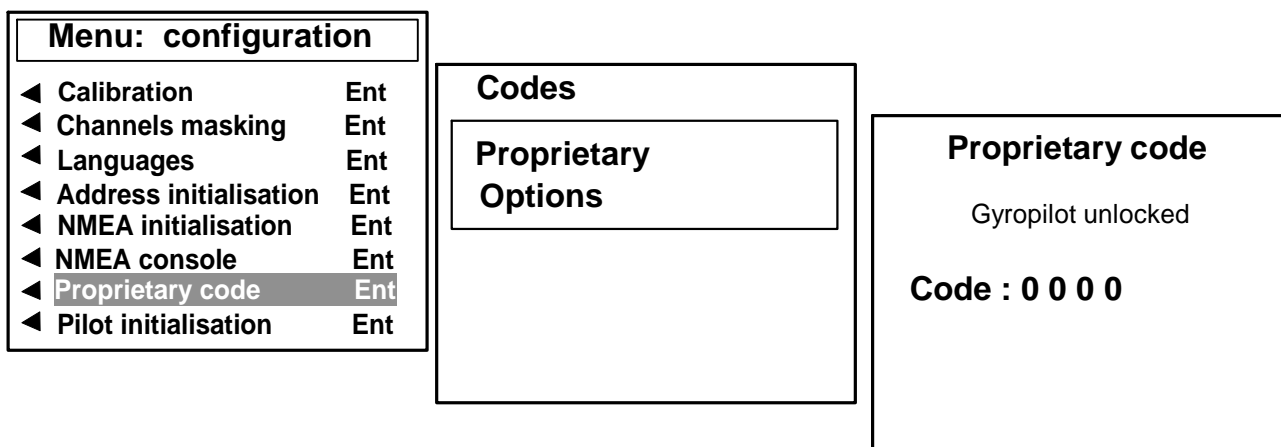

1.7.2 Unlock your security code

You have protected your **Gyropilot Graphic** with a proprietary code. If you wish to access the setting parameters, you must unlock the **Gyropilot Graphic** by entering your proprietary code once more. For this, perform the procedure above and enter your code.



CAUTION:

You have just entered your proprietary code. Keep this number in mind as it will subsequently allow you to unlock your **Gyropilot Graphic**.



1.8 Performing a tacking or jibing manoeuvre under pilot control

The **Gyropilot** allows to perform tacking or jibing manoeuvres under autopilot. In **compass mode**, the value of the tacking angle can be chosen between 70° and 115° in 5° steps. By default the value is 100°. In **wind mode**, the boat will take the same angle of apparent wind on the other side.

Procedure for tacking

- Tacking on starboard side: press the  key, until the rudder initiates the tacking manoeuvre, then release the key.
- Tacking on port side: press the  key, until the rudder initiates the tacking manoeuvre, then release the key.

Procedure for jibing

- Tacking on starboard side: press the  key, until the rudder initiates the tacking manoeuvre, then release the key.
- Tacking on port side: press the  key, until the rudder initiates the tacking manoeuvre, then release the key.

CAUTION:



Never leave the helm without supervision. The helmsman must remain watchful and attentive to the sudden events that can occur while the autopilot is operating. He must be ready to retake control of the rudder at any moment.

1.9 Lighting setting

The **Gyropilot Graphic**, as well as the other displays of the **TOPLINE** range, have five levels of backlighting: 0 = no lighting, 1 corresponds to the minimum level of lighting and 4 to the maximum level.

You have the option to adjust the level of lighting, either solely on the **Gyropilot Graphic**, or on every **TOPLINE** display of your installation:

1.9.1 Setting for the Gyropilot Graphic

- using the **Page** key, select the **Main menu** page,
- using the browser , select **Screen page**, then **Lighting/contrast** and press the **Ent** key,
- using the browser , adjust the level of **lighting** from 0 to 4,
- then press the **Page** key to apply the setting to the **Gyropilot Graphic**.

1.9.2 Setting for every display of your installation

- using the **Page** key, select the **Main menu** page,
- using the browser , select **Screen page**, then **Lighting/contrast** and press the **Ent** key,

- using the browser , adjust the level of **lighting** from 0 to 4,
- then press the **Ent** key to apply the setting to every display.

☛ **Keys for fast access to lighting setting**

- Display the pilot page,
- press the **Ent** key successively to adjust the level of lighting.

☛ **Keys for fast access to lighting setting and contrast**

- Display the pilot page,
- press and maintain the **Ent** key, the following page is displayed:

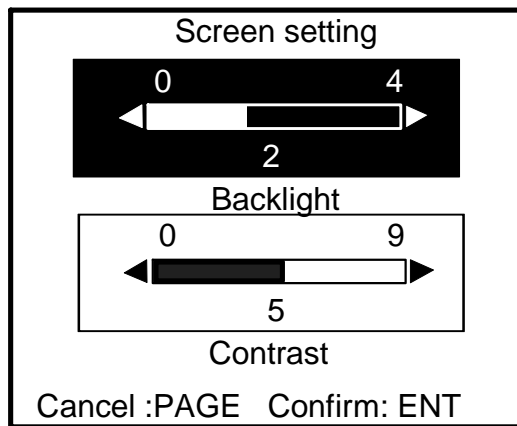

- using the browser , choose the required menu as well as level and press **ENT**.

To have this screen, you can , also , press on the ENT key when you are on the AUTOPILOT page

1.10 Setting the alarms of the pilot

Two programmable alarms are available: one to signal a change of wind direction and the other to signal low battery voltage.

- The wind direction alarm, called « **wind/heading** », allows to monitor a change in wind direction, in **compass mode** and in **wind mode**.

The value entered in **Wind/heading setting** defines a setting range. In **compass mode**, when the wind angle is out of this range, the alarm will be triggered 30s later. In **wind mode**, when the heading is out of this range, the alarm will be triggered 30s later.

- The battery voltage alarm, called « **battery power** », allows to monitor the state of charge of the pilot battery. By default the alarm is set at 8VDC.

1.10.1 Setting procedure:

For example, you wish to set a **wind/heading** alarm of +/-15°: Using the **Page** key, select the **Main menu** page,

- then using the browser , select **Alarms**, then **wind/heading setting**,
- press the **Ent** key,
- using the browser , set the cursor of the **alarm at 15°**,
- validate your setting by pressing the **Ent** key or exit by pressing the **Page** key once.

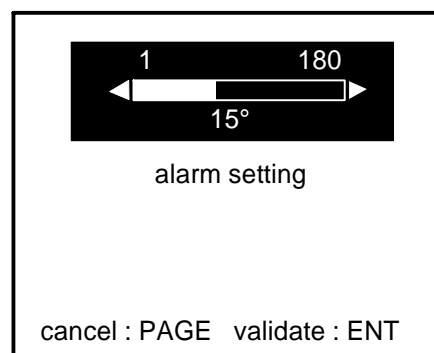
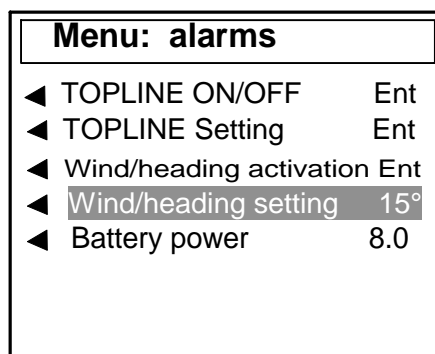
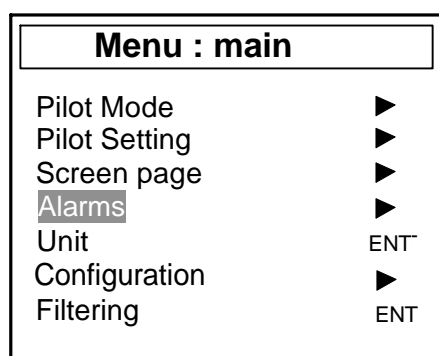

1.10.2 Alarms activation

After setting the **wind/heading** alarm, you can activate or disable it. For that, select the submenu **Activation wind/heading**, then press the **Ent** key.

Please note that the **battery power** alarm is constantly activated.

1.10.3 Suspending an alarm

When an alarm is triggered, you can suspend the alarm for 10 minutes by briefly pressing the **Ent** key.

1.11 Operation of the **GYROPILOT** in degraded mode

The **degraded mode** allows the **GYROPILOT** to continue to operate despite the failure of a sensor.

In **COMPASS MODE**, if the compass breaks down and if the installation is equipped with a wind sensor, the **Gyropilot** automatically switches to **WIND mode**.

In **WIND MODE**, if the wind sensor breaks down, the **Gyropilot** automatically switches to compass mode.

1.12 « MAN OVER BOARD » function

- Man Over Board key

Press this key for 5 seconds, and the function « Man over board » is activated. When a speedometer and a compass are connected to the **TOPLINE bus**, the displays then automatically indicate the estimated heading and distance to reach the man over board. If your installation only comprises a speedometer, then only the estimated distance will be displayed.

To suspend the audible alarm (during the recovery operation of the man over board, for example), press the **Ent** key. The estimated heading and distance to reach the man over board remain on the display.

To disable the « Man over board » alarm, you must **cut off the power supply** of your **TOPLINE** installation. This deactivation procedure is a little long, but allows to save the information of heading and distance of the « Man over board » to the memory, no matter what actions are performed on the **GYROPILOT**.

CAUTION: the calculation of the estimate, for the « Man over board » function, does not take into account the drift of the boat caused by the current and the wind.

1.12.1 Crew mode or solo mode, in **PILOT SETTING** menu

This menu allows to choose the **crew** mode or the **solo** mode when the « Man over board » function is activated:

- In **crew** mode: the activation of the « Man over board » function does not trigger any action on the **Gyropilot**.
- In **solo** mode :

The boat is equipped with a masthead unit sensor.

1. **The Gyropilot is engaged**, in this case, the Gyropilot selects automatically “**wind mode**”, and applies a « 0° » set point in order to position the boat into the wind.
2. **The Gyropilot is not engaged**, in this case, The Gyropilot selects automatically “**Rudder mode**” and positions the rudder with a +/- 40° set point, depending on the previous position of the rudder.

If the boat is not equipped with a masthead unit sensor.

The **Gyropilot** engages the pilot in **rudder mode**, and positions the rudder with a +/- 40° set point, depending on the previous position of the rudder.

In the **pilot setting** menu, select the submenu **Man over board**, and choose the **crew** mode or the **solo** mode.

1.13 Power consumption of the GYROPILOT

On a **TOPLINE** page, you can display the **pilot power** channel. This information is only accessible 10 minutes after the pilot has been operating (pilot engaged). The display of the figure 30.5 means that the engine of the pilot consumes, on average, 30.5 watts:

- using the **Page** key, select the **TOPLINE** display page,
- press the **Ent** key : the selected screen switches to a black background,
- using the **▲** and **▼** keys, select the screen on which you wish to display the **engine power** channel,
- using the **◀** and **▶** keys, select the **engine power** channel,
- press the **Ent** key to validate your selection.

The voltage of the power battery of the pilot is also available through the **pilot voltage** channel.

Please note that the consumption is highly dependent on the sea conditions and the trim.

2. USING THE *GYROPILOT GRAPHIC* IN MULTIFUNCTION DISPLAY MODE

The *Gyropilot Graphic* is a *Multifunction* display of the *TOPLINE* range. Its graphic screen offers excellent readability and a wide angle of view of the data displayed, whether by daylight or at night. It is connected to the *TOPLINE bus* of your installation and allows to display all the channels available on the bus.

Using the keyboard and pull-down menus, the display of the channels and the setup of the sensors become intuitive. The *Gyropilot Graphic* facilitates the reading and control of your *Topline* instruments.

2.1 Configure your display for the display of 1, 2, 3 or 4 channels.

- Using the *Page* key, select the *Main menu* page,
- then using the browser , select *Screen Page*, then the display format,
- press the *Ent* key to validate your selection.

<div style="border: 1px solid black; padding: 5px;"> <p style="text-align: center; margin: 0;">Menu : main</p> <p>Pilot Mode ▶</p> <p>Pilot Setting ▶</p> <p style="background-color: #e0e0e0;">Screen page ▶</p> <p>Alarms ▶</p> <p>Unit ENT</p> <p>Configuration ▶</p> <p>Filtering ENT</p> </div>	<div style="border: 1px solid black; padding: 5px;"> <p style="text-align: center; margin: 0;">Menu : Screen page</p> <p>◀ PILOT page</p> <p>◀ Page X1</p> <p>◀ Page X2</p> <p>◀ Page X3</p> <p style="background-color: #e0e0e0;">◀ Page X4</p> <p>◀ Restore pages</p> <p>◀ Save pages</p> <p>◀ Lighting/contrast</p> </div>
---	--

Examples of display configuration:

<table style="width: 100%; border-collapse: collapse;"> <tr><td style="border: 1px solid black; padding: 2px;">boat speed</td></tr> <tr><td style="font-size: 2em; font-weight: bold;">20.50</td></tr> <tr><td style="font-size: 0.8em;">Knots</td></tr> </table>	boat speed	20.50	Knots	<table style="width: 100%; border-collapse: collapse;"> <tr><td style="border: 1px solid black; padding: 2px;">boat speed</td><td style="border: 1px solid black; padding: 2px;">knots</td></tr> <tr><td style="font-size: 2em; font-weight: bold;">20.50</td><td></td></tr> <tr><td style="border: 1px solid black; padding: 2px;">tr wind ang</td><td style="border: 1px solid black; padding: 2px;">degrees</td></tr> <tr><td style="font-size: 1.5em; font-weight: bold;">➔ 70°</td><td></td></tr> </table>	boat speed	knots	20.50		tr wind ang	degrees	➔ 70°		<table style="width: 100%; border-collapse: collapse;"> <tr><td style="border: 1px solid black; padding: 2px;">boat speed</td></tr> <tr><td style="font-size: 1.5em; font-weight: bold;">20.50 knots</td></tr> <tr><td style="border: 1px solid black; padding: 2px;">true wind angle</td></tr> <tr><td style="font-size: 1.5em; font-weight: bold;">➔ 70°</td></tr> <tr><td style="border: 1px solid black; padding: 2px;">depth</td></tr> <tr><td style="font-size: 1.5em; font-weight: bold;">5.50 meters</td></tr> </table>	boat speed	20.50 knots	true wind angle	➔ 70°	depth	5.50 meters	<table style="width: 100%; border-collapse: collapse;"> <tr><td style="border: 1px solid black; padding: 2px;">boat spd</td><td style="border: 1px solid black; padding: 2px;">depth</td></tr> <tr><td style="font-size: 1.5em; font-weight: bold;">20.5</td><td style="font-size: 1.5em; font-weight: bold;">10.5</td></tr> <tr><td style="font-size: 0.8em;">knots</td><td style="font-size: 0.8em;">meters</td></tr> <tr><td style="border: 1px solid black; padding: 2px;">ang vent rl</td><td style="border: 1px solid black; padding: 2px;">magn hdg</td></tr> <tr><td style="font-size: 1.5em; font-weight: bold;">> 70°</td><td style="font-size: 1.5em; font-weight: bold;">270°</td></tr> </table>	boat spd	depth	20.5	10.5	knots	meters	ang vent rl	magn hdg	> 70°	270°
boat speed																														
20.50																														
Knots																														
boat speed	knots																													
20.50																														
tr wind ang	degrees																													
➔ 70°																														
boat speed																														
20.50 knots																														
true wind angle																														
➔ 70°																														
depth																														
5.50 meters																														
boat spd	depth																													
20.5	10.5																													
knots	meters																													
ang vent rl	magn hdg																													
> 70°	270°																													
<i>page X1</i>	<i>page X2</i>	<i>page X3</i>	<i>page X4</i>																											

2.2 List of channels created

The master display, whether it is the **Gyropilot Graphic** or any other **TOPLINE** display, and each **TOPLINE** sensor, automatically create their respective channels when they are connected to the **TOPLINE bus**. Please refer to the user guides of the sensors and instruments to identify their channels.

	Channel designation
Channels created by the Gyropilot Graphic when set as master display	Magnetic heading
	Apparent wind angle
	Apparent wind speed
	Depth
	Surface speed
	Maximum and average speed
	Distance and heading to man over board
	Configuration
	Bus voltage
	VMG
	CMG
	True wind speed
	True wind angle
	True wind direction
	Corrected heading
	Estimated distance
	Estimated angle
	Total log
	Daily log
NMEA Performance channels displayed	Target speed
	Heading on other side
	Optimum wind angle
	Optimum VMG angle
	Optimum CMG angle
	Efficiency at close-haul
Polar efficiency	
NMEA channels displayed	Bottom speed and bottom heading
	Cross-track error

Please note that the **MAX SPD** and **AVRG SPD** channels are displayed alternatively on one single screen. By default, these two channels are calculated using the surface speed, and in the absence of the latter they will be calculated using the bottom speed. These values, average and maximum, are calculated from the time your installation is powered up.

You can reset these channels using the following procedure:

- Using the **Page** key, select the **Main menu** page,
- then using the browser , select **Configuration** then **calibration**,
- press the **Ent** key,
- in the list of channels, select **average speed**, then press the **Ent** key,
- select **yes** to reset the channel, or exit by pressing the **Page** key.

2.3 Configuring the display of the channels

The display Windows of the **Gyropilot Graphic** are independent. Configure the channels according to your requirements:

Example, you want to replace the channel **boat speed** by the channel **depth** :

- You have the option to backup nine setup configurations of the pilot,

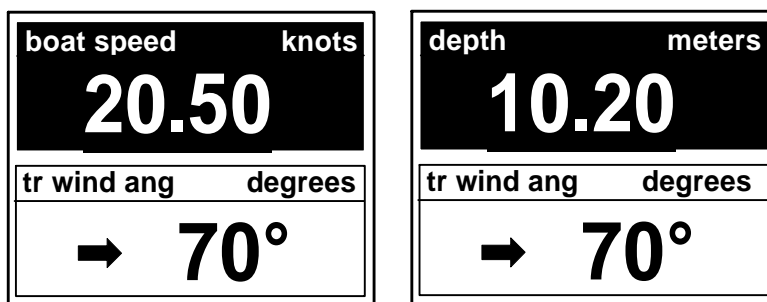



- press the **Ent** key to validate your selection.

2.4 Display configurations backup and restore

You have the option to backup nine setup display configurations.

To save a configuration:

- In the **Main menu**, select the **Save pages** menu, and press the **Ent** key,
- select the number of the configuration you wish to save.
- using the browser  and the screen keyboard, enter the name of your configuration. (Each letter that is part of the name must be validated by pressing the **Ent** key).
- validate the name you have entered by pressing the  key.

To restore a configuration :

- In the **Main menu**, select the **restore pages** menu, and press the **Ent** key,
- select the number of the configuration you wish to display.

 **Useful tip:**

- Press the **Ent** until the display is in black screen,
- Using the the browser keys , select the configuration you need.

2.5 What is a sub-channel?

The sub-channels correspond to the setting and display parameters of the channels. For example, the sub-channels of the **boat speed** channel are:

- the **offset** and the **calibration coefficient** : setting parameters of the sensor,
- the measurement **unit** : in knots or in km/hr,
- the **filter** setting,
- the setting of the **upper alarm** and the **lower alarm**.

The following chapters provide detailed explanations on how to access the sub-channels via the main channel and implement the settings.

2.6 Alarms setting for the channels of TOPLINE instruments

The setting of an alarm enables you to monitor the value of a channel. When the preset threshold is exceeded, a warning message is displayed and an audible alarm is activated. For example, you can set an upper threshold and a lower threshold on the **surface speed** channel.

The upper alarm is activated when the display is higher than the programmed threshold.

The lower alarm is activated when the display is lower than the programmed threshold.

To cancel the alarm of a channel, enter the value **0** in the upper alarm and the lower alarm.

Thus, the setting of the alarms will allow you to supervise your **TOPLINE** installation effectively, as well as the good operation of your boat.

Note that for angular channels such as **magnetic heading** or **wind angle**, the sub-channels of alarms are the **alarm base** and the **alarm fork**

CAUTION:

The **air temperature** and **water temperature** channels have a distinctive feature. To cancel the alarm of this channel, enter the value **0**, when the unit is the degree Fahrenheit, or **-17.7**, when the unit is the degree Celsius. Enter the value in the upper alarm and the lower alarm.

2.6.1 Setting procedure

Example: set the alarm of the **surface speed** channel, 10 knots for the **upper alarm** and 1 knot for the **lower alarm**.

- Using the **Page** key, select the **Main menu** page,
- then using the browser , select **Alarms**, then **TOPLINE setting**,
- press the **Ent** key,
- select **surface speed** in the list of channels, then press the **Ent** key,

- using the browser , set the **upper alarm** then the **lower alarm**,
- validate your setup by pressing the **Ent** key or exit by pressing the **Page** key.

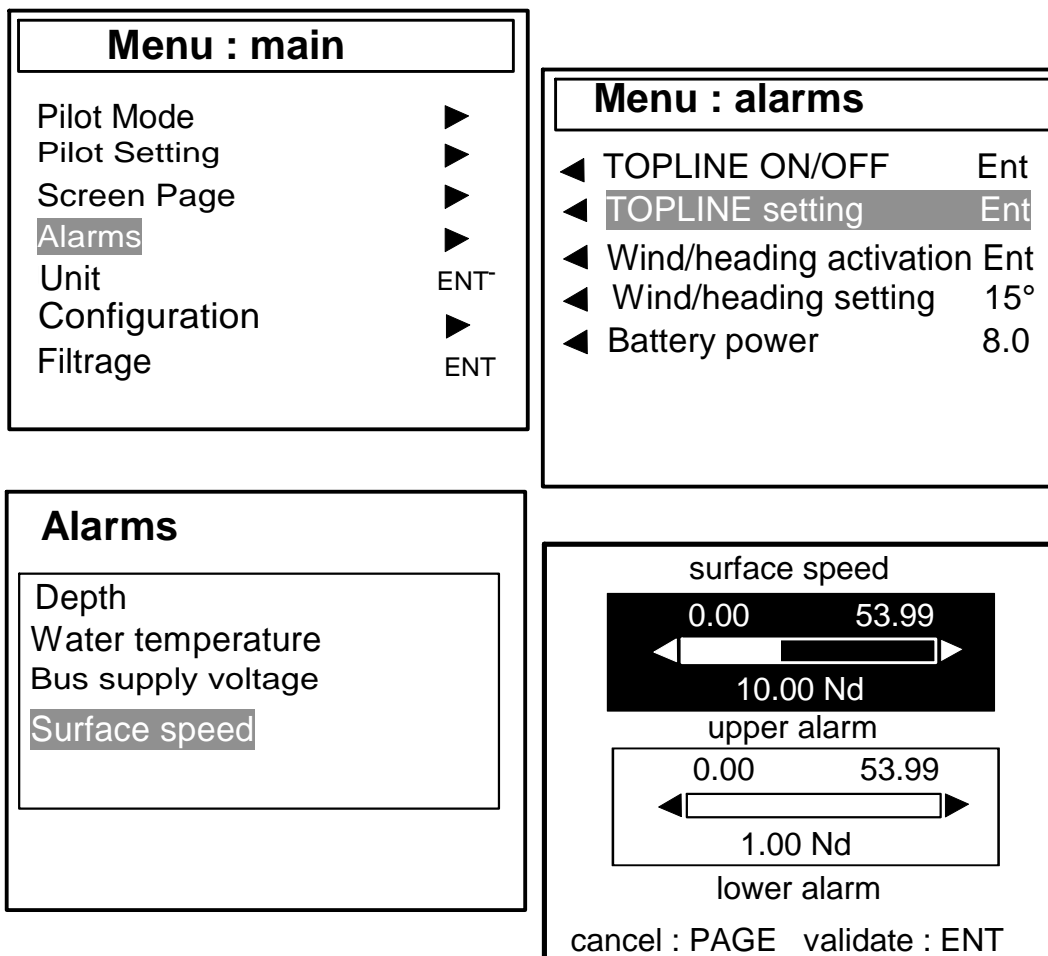

The image shows four sequential screenshots of the device's menu system:

- Menu : main**: A list of menu items with right-pointing arrows. 'Alarms' is highlighted. 'Unit' and 'Filtrage' have 'ENT' labels next to their arrows.
- Menu : alarms**: A list of alarm settings with left-pointing arrows. 'TOPLINE setting' is highlighted. Other items include 'TOPLINE ON/OFF', 'Wind/heading activation', 'Wind/heading setting', and 'Battery power'.
- Alarms**: A list of alarm types. 'Surface speed' is highlighted.
- surface speed**: A graphical interface for setting the upper and lower alarm thresholds. It shows a scale from 0.00 to 53.99. The upper alarm is set to 10.00 Nd and the lower alarm is set to 1.00 Nd. At the bottom, it says 'cancel : PAGE validate : ENT'.

2.6.2 Activating and disabling the alarms

After having set the alarms thresholds, you can activate or disable all the alarms. For that, select the sub-menu **TOPLINE ON/OFF** (see above), then press the **Ent** key.

2.6.3 Suspending an alarm

Please note that when an alarm is triggered, you can suspend the audible alarm for 10 minutes, by briefly pressing the **Ent** key.

2.7 Filtering of the channels

The level of **filtering** of a channel determines the frequency of update of the data displayed.

For example, in rough sea when the boat moves significantly, it is useful to increase the filtering of the speed channel to stabilise the value displayed. Conversely, in calm sea, low filtering will be preferable to obtain a fast response of the display.

Filtering is adjustable between **1** and **32**, and the default value is **8**. The lower this value, the higher the frequency of update.

Procedure

- Using the **Page** key, select the **Main menu** page,
- then using the browser , select **Filtering**, then press the **Ent** key,
- select the channel you wish to filter from the list, then press the **Ent** key,
- using the browser, set the filtering cursor at the required value,
- validate your setting by pressing the **Ent** key, or exit by pressing the **Page** key.

2.8 Choice of the unit

You have the option to choose the display units of the channels:

- in knots or in km/hr for the log/speedometer and the bottom speed (GPS),
- in knots or m/s for the anemometer,
- in degree Fahrenheit or in degree Celsius for the temperature
- in meters or in feet for the depth sensor.

Procedure

- Using the **Page** key, select the **Main menu** page,
- then using the browser select **Unit**, then press the **Ent** key,
- select the channel for which you wish to change the unit, then press the **Ent** key,
- using the browser, select the unit,
- validate your selection by pressing the **Ent** key, or exit by pressing the **Page** key.

2.9 Zero setting of the daily log

The channels **daily log** and **total log** are at your disposal on your display.

You will use the daily log to count the number of nautical miles completed during a sailing leg. The value is kept in memory when the power supply of your installation is cut off. Resetting the **daily log** channel to zero will allow you to count the number of nautical miles of the following sailing leg:

- Using the **Page** key, select the **Main menu** page,
- then using the browser , select **Configuration** then **calibration**,
- press the **Ent** key,
- in the list of channels, select **Daily log**, press the **Ent** key,
- the question « **Are you certain you wish to reset the channel** » is displayed on the screen,
- select **yes** then press the **Ent** key or exit by pressing the **Page** key.

The **total log** indicates the number of nautical miles completed since the installation of your **depth-finder log interface**. Only a complete initialisation of your **depth-finder log interface** allows to reset the **total log** to zero. It is performed by initialising the **surface speed** channel. During this operation, the settings of the speedometer, log, depth and water temperature are reset to the default factory values.

2.10 Choice of languages

You can configure the **Gyropilot Graphic** in one of these six available languages: French, English, Italian, Spanish, German and Dutch.

- Using the **Page** key, select the **Main menu** page,
- then using the browser , select **Configuration** then **languages**
- press the **Ent** key,
- make your selection from the list of available languages,
- press the **Ent** key to validate your selection or exit by pressing the **Page** key.

2.11 Use of the chronometer

The **Gyropilot Graphic** includes a regatta chronometer. Times by default are T1= 6min and T2 = 4min.

2.11.1 Preparing and starting the chronometer

- Using the **Page** key, select the **TOPLINE** display page,
- press the **Ent** key : the selected screen switches to a black background,
- using the ◀ and ▶ keys, select the **chronometer** channel,
- press the **Ent** key to validate your selection,
- the chronometer is ready to be started,
- at the start signal, press the **Ent** key to start the chronometer.

During countdown, the last 5 seconds are signalled by a BEEP, then the START signal is given by the alarm.

Note that if you did not start the chronometer exactly at the start signal, you can synchronise the chronometer countdown at T2 by pressing the **Ent** key. During the procedure, you can also return to the initialisation value by pressing the **Ent** key for 2 seconds. The chronometer displays T1 = 6.00 minutes, for a new start.

2.11.2 Setting of T1 and T2

- Using the **Page** key, select the **Main menu** page,
- then using the browser, select **Configuration** then **calibration**,
- press the **Ent** key,
- in the list of channels, select **chronometer**, press the **Ent** key,
- using the browser, set the cursor of **T1**, then the cursor of **T2**,
- validate your setting by pressing the **Ent** key or exit by pressing the **Page** key.

2.12 NMEA LINK

The **Gyropilot Graphic** includes an NMEA input, allowing the connection of a GPS or any other instrument providing NMEA frames : PC, meteorological sensors, etc. After performing the NMEA initialisation of the **Gyropilot Graphic**, the NMEA channels corresponding to the frames transmitted by the instrument are available on the **TOPLINE bus**. You can then display data.

Please note that if an instrument transmits an NMEA frame which is already created by an **nke** sensor, then this frame will not be taken into account.

2.12.1 Connection of the NMEA link

The NMEA input of the **Gyropilot Graphic** only allows the connection of one instrument providing NMEA frames (see installation chapter). If you wish to connect a second instrument (for example a GPS and a PC), you must connect it either to the NMEA input of another display or to a **TOPLINE NMEA INPUT INTERFACE** (ref: 90-60-055).

2.12.2 Initialisation procedure for the NMEA bus

- Using the **Page** key, select the **Main menu** page,
- then using the browser, select **Configuration** the **NMEA initialisation**,
- press the **Ent** key and follow the instructions displayed,

The **Gyropilot Graphic** subsequently performs a sequence of NMEA data search for 20 seconds, then it creates the new channels corresponding to the NMEA frames transmitted by the instrument. The NMEA channels created are saved in the display memory and restored every time it is powered up.

2.12.3 Frames identified by the Gyropilot Graphic

The NMEA frames identified by the **Gyropilot Graphic** are in conformity with the NMEA standard 0183 V2.30 (or lower version).

The NMEA input is insulated by an optocoupler.

The format of the frames is: 4,800 bauds / 8 bits with bit 7 at 0 / 1 start bit and 1 stop bit.

Distances are truncated to the lower value and the other dimensions are rounded to the nearest unit (ex: degrees for angles).

A frame can be partially empty between the commas.

The **Gyropilot Graphic** will take the missing data in another frame (ex: speedo in VWH and compass in HDG). The depth in feet will be identified if it does not exist in meters for example. A channel can be included in several frames (ex: the compass is taken in HDG in priority, if not in HDM, if not in VHW). If the bottom heading or the WP heading do not exist in magnetic, the true heading is taken.

Refreshing of the display of the NMEA channels is performed each time a new valid NMEA frame is received. If the NMEA link is lost (example: loss of satellites on the GPS) the last received data will remain on the display for 64 seconds. After that, the **Gyropilot Graphic** will signal the breakdown.

NMEA Frame	Description	TOPLINE channels created
\$xxGLL	Latitude, longitude, time and quality index	<i>LAT_DEGMIN, LAT_MILMIN, LON_DEGMIN, LON_MILMIN.</i>
\$xxGGA	Latitude, longitude and time	<i>LAT_DEGMIN, LAT_MILMIN, LON_DEGMIN, LON_MILMIN.</i>
\$xx-ZDA	Date and time	<i>ANNMOIS, HEUJOUR, MINSEC.</i>
\$xxRMC	Latitude, longitude, date, time, bottom heading, bottom course and compass correction : in minimum data ;	<i>ANN_MOIS, HEU_JOUR, MIN_SEC,CAP_FOND,V_FOND,LAT_DEGMIN ,LAT_MILMIN,LON_DEGMIN,LON_MILMIN</i>
\$xxVTG	Bottom speed and course	<i>CAP_FOND, V_FOND.</i>
\$xxXTE	Cross-track error	<i>ECART_ROUTE, B_PILOT, C_WP_OD.</i>
\$xxAPB	Automatic pilot in A format	<i>ECART_ROUTE, B_PILOT, C_WP_OD.</i>
\$--RMB	XTE, latitude, longitude and distance and heading to destination (DTW and BTW) in minimum data.	<i>A_WP, D_WP</i>
\$xxBWC	distance and heading to destination (DTW and BTW)	<i>A_WP, D_WP</i>
\$xxXDR	Measurement transmitter : stays tension or temperature	<i>TEN_ETAIS.</i>
\$xxHDG	Magnetic heading, deviation and variation	<i>COMPAS, R_COMPAS.</i>
\$xxVHW	Surface speed, magnetic and true heading	<i>COMPAS, R_COMPAS, SPEEDO</i>
\$xxHDM	Magnetic heading, deviation and variation	<i>COMPAS, R_COMPAS.</i>
\$xxVLW	Surface distance	<i>LOCHJ, LOCHT.</i>
\$xxDBT	Depth beneath transducer	<i>PROF</i>
\$xxDPT	Depth beneath transducer and offset	<i>PROF</i>
\$xxMTW	Water temperature	<i>TEMP_EAU.</i>
\$xxMWV	Wind speed and wind angle	<i>ANG_VENT_APP, R_ANG_VENT_APP, ANEMO.</i>
\$xxVWR	Apparent wind speed and wind angle	<i>ANG_VENT_APP, R_ANG_VENT_APP, ANEMO.</i>
\$xxMMB	Atmospheric pressure	<i>BARO_2.</i>
\$xxMTA	Air temperature	<i>TEMP_AIR</i>
\$PNKEP,01	Target speed	<i>VIT_CIBLE.</i>
\$PNKEP,02	Heading at next leg	<i>CAP_AUTRE_BORD.</i>
\$PNKEP,03	Optimum upwind angle	<i>ANGLE_OPT_VENT, REND_PRES, REND_POLAIRE.</i>
\$PNKEP,04	Angles to optimise the CMG and VMG and gain	<i>ANGLE_OPT_CMG, ANGLE_OPT_VMG, GAIN_ROUTE_CMG, GAIN_ROUTE_VMG.</i>
\$PNKEP,05	Current direction and speed	<i>DIREC_COURANT, VITES_COURANT.</i>

2.13 The NMEA console: a tool to visualise the NMEA frames

The **NMEA console** of the **Gyropilot Graphic** allows to read the NMEA frames, which are provided by the instrument which is connected (GPS, PC, barometer). Thus, the **NMEA console** works out to be a practical tool for setting up your installation.

It is easy to use; follow the operating procedure below:

- Using the **Page** key, select the **Main menu** page,
- then using the browser , select **Configuration**, then **NMEA console**,
- press the **Ent** key : the console displays the NMEA frames in real time.

```
$GPGGL,0047.705,N0006.45,172523.23A
$GPVTG,270.5,T,,012.3,N,022.7,K
```

Start / stop : Ent Menu : Page

2.14 Technical specifications

- Power supply : 10 to 16VDC
- Consumption: 30mA without lighting and 50mA with lighting.
- Tightness : IP67
- Weight : 1.3kg, including cable
- Bus cable: Ø 5.8 ± 0.3; weight = 50 g/m.
- Dimensions : height = 118mm ; width = 181mm ; thickness = 32.5mm
- Operating temperature : -10°C to +50°C
- Storage temperature : -20°C to +60°C
- Horizontal viewing angle : superior to 120°
- Vertical viewing angle : superior to 90°

2.15 Version of the GYROPILOT GRAPHIC

Follow the procedure below to display the software version of the display:

- Using the **Page** key, select the **Main menu** page,
- then using the browser, select **Configuration**, then **address initialisation**,
- press the **Ent** key : the software version is displayed at the bottom of the screen,
- press the **Page** key to exit this menu.

2.16 Diagnostic for 1st level troubles shooting.

This chapter can help you rapidly resolve minor problems which do not require the intervention of a specialist. Before contacting technical support, please check the troubleshooting table below.

Problem	Possible causes and solutions
The Topline installation does not detect the Gyropilot Graphic	The bus cable is not or is badly connected to the terminal box: check the plugging and the connection inside the terminal box. Check the state of the cables: they must not show any sign of wear or cut.
The Gyropilot Graphic displays the message « master absent »	Initialise the Gyropilot Graphic : see installation chapter.
The Gyropilot Graphic displays the message « bus error. The data cable (black) is in short-circuit »	Check that the black data wire is properly connected inside the terminal box: see installation chapter.
The Gyropilot Graphic display three dashes « - - - » in place of the data of a channel.	Check the sensor of this channel, check the connection cable: it may be damaged or disconnected.
The Gyropilot Graphic displays the message « bus error : conflict problem »	It may be that there are two master displays (at address 1) on your installation: check the addresses, if that is the case, reinitialise one of the displays.
The Gyropilot Graphic does not display the NMEA data: those from the GPS for example.	Has the NMEA link been initialised? see NMEA initialisation chapter The NMEA link is not or is badly connected to the terminal box: check the connection of the Gyropilot Graphic and that of the NMEA transmitter (GPS). See installation chapter.
The Gyropilot Graphic displays the message « low battery »	Check the voltage of your battery with a voltmeter: the operating voltage must be above 10VDC. Check that the battery maintains the load.
The Gyropilot Graphic indicates « Error EPROM ».	Reinitialise your Gyropilot Graphic . If the error message persists, please contact your distributor.

If you do not manage to solve the problem, please contact your distributor.

2.17 Initialisation of the **Gyropilot Graphic**: see chapter 4.6

3. SENSOR CALIBRATION

Every *nke* sensor is adjusted at the factory. However, a calibration is required to adapt the sensor to the specificities of your boat and to obtain an optimum measurement accuracy. Follow the calibration procedure below, by visualising the settings on a display.

Please refer to the installation notice of the **TOPLINE** sensor that you wish to calibrate.

3.1 Setting procedure of the calibration coefficient

Example: setting the calibration coefficient of the *boat speed* channel at the value **1.1**.

- Using the **Page** key, select the **Main menu** page,
- then using the browser, select **Configuration** then **calibration**,
- press the **Ent** key,
- in the list of channels, select **boat speed**, press the **Ent** key,
- select **calibration** then press the **Ent** key,
- using the browser, set the cursor of the calibration coefficient at **1.1**,

validate your setting by pressing the **Ent** key, or exit by pressing the **Page** key

<div style="border: 1px solid black; padding: 5px;"> <p style="text-align: center; margin: 0;">Menu : main</p> <table style="width: 100%; border-collapse: collapse;"> <tr><td>Pilot Mode</td><td style="text-align: right;">▶</td></tr> <tr><td>Pilot Setting</td><td style="text-align: right;">▶▶</td></tr> <tr><td>Screen Page</td><td style="text-align: right;">▶▶▶</td></tr> <tr><td>Alarms</td><td style="text-align: right;">▶▶▶▶</td></tr> <tr><td>Unite</td><td style="text-align: right;">ENT</td></tr> <tr><td style="background-color: #cccccc;">Configuration</td><td style="text-align: right;">▶</td></tr> <tr><td>Filtering</td><td style="text-align: right;">ENT</td></tr> </table> </div>	Pilot Mode	▶	Pilot Setting	▶▶	Screen Page	▶▶▶	Alarms	▶▶▶▶	Unite	ENT	Configuration	▶	Filtering	ENT	<div style="border: 1px solid black; padding: 5px;"> <p style="text-align: center; margin: 0;">Menu: configuration</p> <table style="width: 100%; border-collapse: collapse;"> <tr><td style="background-color: #cccccc;">◀ Calibration</td><td style="text-align: right;">Ent</td></tr> <tr><td>◀ Channels masking</td><td style="text-align: right;">Ent</td></tr> <tr><td>◀ Languages</td><td style="text-align: right;">Ent</td></tr> <tr><td>◀ Address initialisation</td><td style="text-align: right;">Ent</td></tr> <tr><td>◀ NMEA initialisation</td><td style="text-align: right;">Ent</td></tr> <tr><td>◀ NMEA console</td><td style="text-align: right;">Ent</td></tr> <tr><td>◀ Proprietary code</td><td style="text-align: right;">Ent</td></tr> <tr><td>◀ Pilot initialisation</td><td style="text-align: right;">Ent</td></tr> </table> </div>	◀ Calibration	Ent	◀ Channels masking	Ent	◀ Languages	Ent	◀ Address initialisation	Ent	◀ NMEA initialisation	Ent	◀ NMEA console	Ent	◀ Proprietary code	Ent	◀ Pilot initialisation	Ent
Pilot Mode	▶																														
Pilot Setting	▶▶																														
Screen Page	▶▶▶																														
Alarms	▶▶▶▶																														
Unite	ENT																														
Configuration	▶																														
Filtering	ENT																														
◀ Calibration	Ent																														
◀ Channels masking	Ent																														
◀ Languages	Ent																														
◀ Address initialisation	Ent																														
◀ NMEA initialisation	Ent																														
◀ NMEA console	Ent																														
◀ Proprietary code	Ent																														
◀ Pilot initialisation	Ent																														

<div style="border: 1px solid black; padding: 5px;"> <p style="text-align: center; margin: 0;">Calibration</p> <div style="border: 1px solid black; padding: 5px; min-height: 80px;"> <p>depth</p> <p>water temperature</p> <p>bus supply voltage</p> <p style="background-color: #cccccc;">boat speed</p> </div> <p style="margin-top: 10px;">validate : ENT Menu: PAGE</p> </div>	<div style="border: 1px solid black; padding: 5px;"> <p style="text-align: center; margin: 0;">boat speed</p> <div style="border: 1px solid black; padding: 5px; min-height: 80px;"> <p>Init</p> <p style="background-color: #cccccc;">Calibration</p> <p>Offset</p> </div> <p style="margin-top: 10px; text-align: center;">To return to the menu press page</p> </div>	<div style="border: 1px solid black; padding: 5px; text-align: center;"> <p>boat speed</p> <div style="border: 1px solid black; padding: 5px; margin: 5px auto; width: 80%;"> <p style="display: flex; justify-content: space-between; width: 100%;"> 0.00 10 </p> <p style="text-align: center;">1.1</p> </div> <p>calibration</p> <p style="margin-top: 10px;">Cancel : PAGE Validate: ENT</p> </div>
---	---	--

CAUTION:

The *air temperature* and *water temperature* channels have a distinctive feature. To cancel the alarm of this channel, enter the value **0**, when the unit is the degree Fahrenheit, or **-17.7**, when the unit is the degree Celsius. Enter the value in the upper alarm and the lower alarm.

3.2 Offset setting

Follow the procedure above and select the sub-channel **OFFSET**.

Please note that by default, the value of the offset is **0**.

3.3 Autocompensation of the fluxgate compass

It is possible that on some boats, the **Fluxgate Compass** may be strongly disrupted by its environment. Despite a careful installation and an offset properly adjusted, an important difference remains between the **magnetic heading** displayed and the true magnetic heading, throughout the measurement range between **0** and **359°**. In this case, you must perform an autocompensation of the **Fluxgate Compass** to achieve an acceptable level of accuracy.

Please refer to the installation guide of the **Fluxgate Compass** sensor.

3.3.1 Principle of the autocompensation

The operation consists in executing, **at a rigorously constant rotation speed**, a perfect circle with your boat, **clockwise**. While the boat describes this circle, the sensor will record the measurement points of a deviation curve, every 10° with an accuracy of 0.25°. Thus, your **Fluxgate Compass** will be accurately corrected between **0** and **359°**.

CAUTION: the autocompensation operation of the Fluxgate Compass requires precision in the execution of the circle: constant rotation speed of 2 to 3 knots and constant diameter of the circle. If you cannot maintain these two criteria, the autocompensation will not be successful.

3.3.2 Autocompensation procedure for the Fluxgate Compass

In order to achieve a successful autocompensation, you must navigate:

- On smooth sea, with no current and no wind.
- Away from large magnetic masses such as cargo boats.
- In an open area allowing the execution of a circle with a diameter approximately 5 times the length of the boat.
- At a constant speed of about 2 or 3 knots.
 - Using the **Page** key, select the **Main menu** page,
 - then select **Configuration** then **calibration**,
 - press the **Ent** key,
 - in the list of channels, select **magnetic heading**, press the **Ent** key,
 - select **autocompensation**, then press the **Ent** key,
 - Start to describe the circle, then press the **Ent** key to launch the autocompensation procedure. One single circle* is sufficient to perform the autocompensation correctly,
 - a message indicates whether the autocompensation is successful or not,
 - exit the setting mode by pressing the **Page** key.

* For the previous generation of compass, referenced as 90-60-005, at least three circles must be executed.

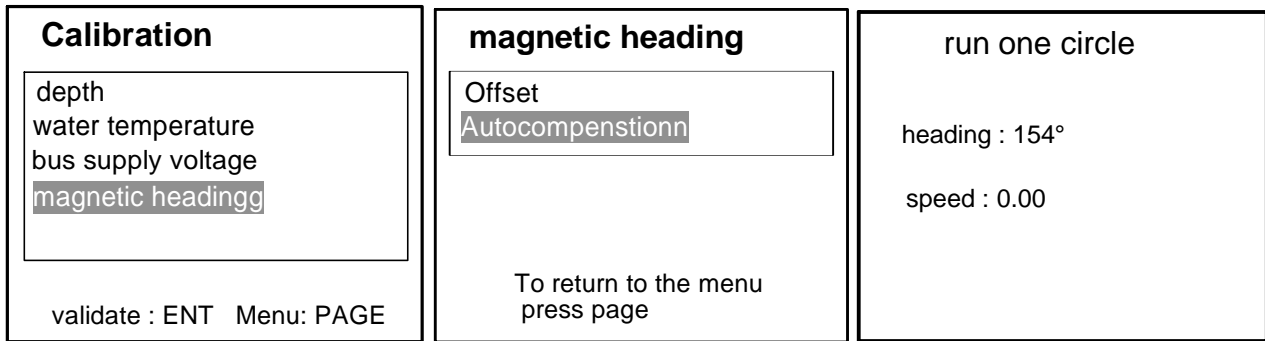

In case of problem during autocompensation, the **Gyropilot Graphic** displays the following error messages:

- Cancellation at user request.
- Detection of a gyration in the opposite direction. Start again clockwise.
- Excessive variation between 2 heading measurements. Reduce the speed of your boat to 2 or 3 knots.
- Angle correction higher than 20°. Start the autocompensation procedure over.

In case of autocompensation error, the measurements are not saved to the memory and the sensor resumes its normal operating mode.

3.4 Setting the depth-finder blanking

In order to remove any keel echo, which makes the depth-finder freeze on a fixed value, it is possible to set a blanking minimum, which allows the depth-finder not to take into account the echoes reflected between the transducer and the screening value.

3.4.1 Procedure for setting the depth-finder blanking

- Using the **Page** key, select the **Main menu** page,
- Then using the browser , select **Configuration** then **calibration**,
- Press **Ent**,
- In the list of channels, select **depth**, then press **Ent**,
- Select **Blanking** then press **Ent**, the following page is displayed:

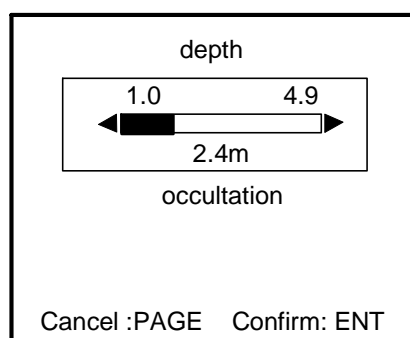

- Using the browser , move the cursor to the selected blanking value,

- Validate your setting by pressing **Ent**, or exit by pressing **Page**.

4. CALIBRATION UTILITIES

4.1 Automatic calibration of boat speed

4.1.1 Principle

This involves calibrating the boat speed in relation to the speed over ground. In order to do this, one must sail approximately 0.5 miles while maintaining a constant heading, then sail back approximately the same distance using the opposite heading. Calculation of the new calibration is done based on the calibration already saved (it is not necessary to set the speedometer calibration back to 1).

To perform this automatic calibration of the speedometer, it is imperative that the “speed over ground” is displayed on the Topline network.

4.1.2 Procedure for automatic calibration of the speedometer

- Using the **Page** key, select the **Main menu** page,
- Then using the browser , select **Configuration** then **calibration**,
- Press **Ent**,
- In the list of channels, select **boat speed**, then press **Ent**,
- Select **calibration** then press **Ent**
- Select **Auto** then press **Ent**, the following page is displayed:

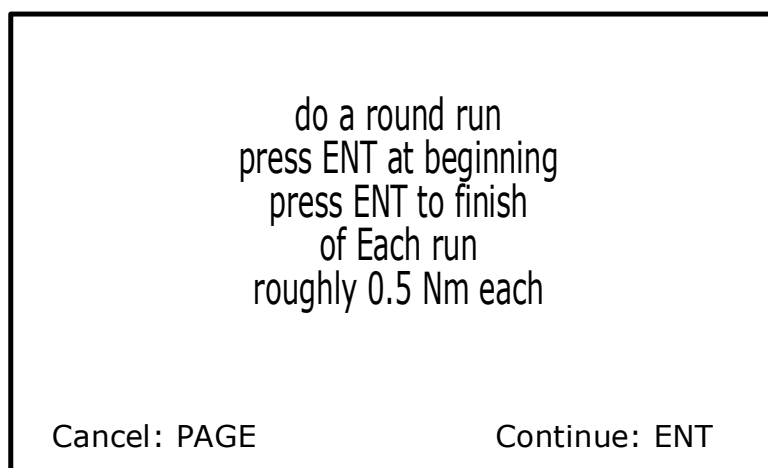

- Press **Ent** once again, the following page is displayed:

Follow a COG	
Press ENT	
Boat speed	X.XX KT
COG	SOG
XXX°	X.XX
Cancel: PAGE	Start: ENT

- Stabilize heading and speed, press **Ent** to start the calibration procedure, the following page is displayed:

COG to follow	XXX °
Boat Loch	X.XX Mn
Over Ground Loch	X.XX Mn
Boat speed	X.XX KT
COG	SOG
XXX°	X.XX
Cancel: PAGE	End ENT

- Sail a over ground distance of approximately 0.5 mile while maintaining a constant course over ground, then press **Ent**, the following page is displayed:

Come to COG	
Press ENT	
boat speed	X.XX KT
COG	SOG
XXX°	X.XX
Cancel: PAGE	Start: ENT

- Come to the course over ground indicated (opposite of the previous heading), stabilize your boat on this new heading then press **Ent**, the following page is displayed:

COG to follow	XXX	°
Boat Loch	X.XX	Mn
Over Ground Loch	X.XX	Mn
Boat speed	X.XX	KT
COG	SOG	
XXX°	X.XX	
Cancel: PAGE		End ENT

- Sail a over ground distance of approximately 0.5 mile once again, then press **Ent**, the following page is displayed:

Record coeff?	
Old coeff:	X.XX
New coeff:	X.XX
Return Coeff	X.XX / X.XX
Correction	XX.XX
Yes	
no	
Cancel: PAGE	Confirm: ENT

- This page displays the value of the calibration coefficient currently saved in the Log depth interface (Old coef), the new calibration coefficient calculated (New coef), the coefficients calculated during the return trips (return coef) as well as the correction percentage to be applied to the surface speed. If you wish to save this new calibration coefficient, select **Yes** using the browse  then press **Ent**. Your speedometer sensor is now calibrated. If you do not wish to save this new coefficient, press **page**.

4.2 Calibration of the nke compass based on the correction table.

4.2.1 Principle

This involves manually or automatically completing a correction table. This correction table allows the headings of the nke compass to be corrected every 30°.

4.2.2 Manual calibration of the nke compass.

The method consists in plotting the deviation curve every 30°, by performing plots on alignments, or by comparing the various headings in relation to a calibrated compass.

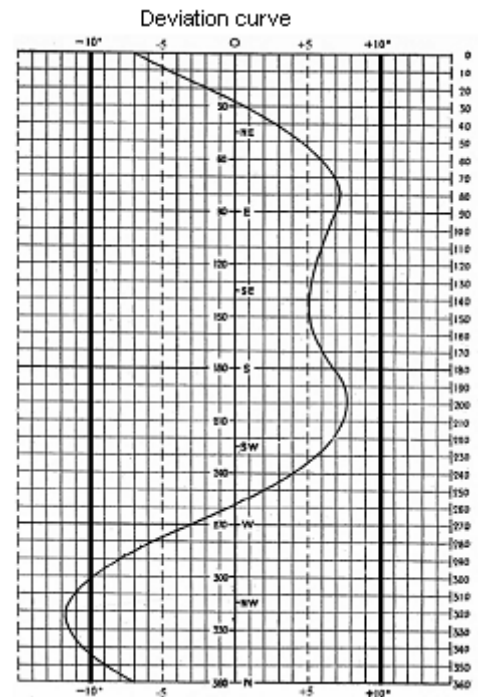

4.2.3 Procedure for manual calibration of the nke compass

- Using the **Page** key, select the **Main menu** page,
- Then using the browser , select **Configuration** then **calibration**,
- Press **Ent**,
- In the list of channels, select **Compass head**, then press **Ent**,
- Select **Correction table** then press **Ent**
- Select **Manual** then press **Ent**, the following page is displayed:

Manual Calibration		
0°	30°	60°
90°	120°	150°
180°	210°	250°
270°	300°	330°
Cancel: PAGE		Calibrate: ENT

- Using the browser , select the value to be modified in the table, then press **Ent**, the following page is displayed:

Actual correction for XXX° XX°	
HEADING	CORRECTION
XXX°	XX° ▲ ▼
Cancel: PAGE	Confirm: ENT

- Using the browser, enter the new correction value (current correction ± correction value plotted), then press **Ent**, the following page is displayed:

Record correction?	
Old correction:	XX°
New correction:	XX°
Yes	
no	
Cancel: PAGE	Confirm: ENT

- Using the browser , select **Yes**, then press **Ent** to save this new correction. If you do not wish to save this correction, directly press **Ent**. Repeat this operation every 30° in order to complete the correction table. Once this correction table is complete, your compass is corrected of deviation curve.

4.2.4 Procedure for automatic calibration of the nke compass

- Using the **Page** key, select the **Main menu** page,
- Then using the browser , select **Configuration** then **calibration**,
- Press **Ent**,
- In the list of channels, select **compass head**, then press **Ent**,
- Select **Correction table** then press **Ent**
- Select **Auto** then press **Ent**, the following page is displayed:

Auto calibration		
0°	30°	60°
90°	120°	150°
180°	210°	250°
270°	300°	330°

Cancel: PAGE Calibrate: ENT

- Using the browser , select the value to be modified in the table, then press **Ent**, the following page is displayed:

Keep a compass of xxx° a +/- 10°	
HEADING	REF HEADING
xxx°	xx° 

Cancel: PAGE Confirm: ENT

- Maintain the required nke compass heading at $\pm 10^\circ$, then plot the reference heading and enter it using the browser , then press **Ent**, the following page is displayed:

Record correction?	
Old correction:	xx°
New correction:	xx°
Yes	
no	

Cancel: PAGE Confirm: ENT

- Using the browser , select **Yes**, then press **Ent** to save this new correction. If yo do not wish to save this correction, directly press **Ent**. Repeat this operation every 30° in order to complete the correction table. Once this correction table is complete, your compass is corrected of the deviation curve.

4.3 Calibration of apparent wind angle

4.3.1 Principle

This involves performing 4 close-hauled tacks in order to record the average apparent wind angle on each tack, and calculating the wind vane offset to be saved in the mastheadunit in order to have an accurate measurement of apparent wind angle.

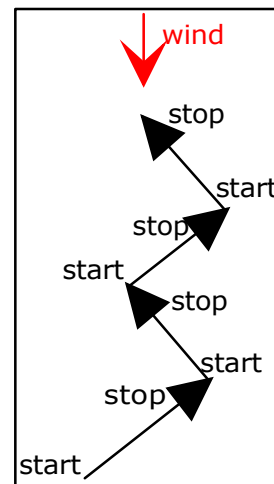

4.3.2 Procedure for the calibration of apparent wind angle

- Using the **Page** Key, select the **Main menu** page,
- Then using the browser , select **Configuration** then **calibration**,
- Press **Ent**,
- In the list of channels, select **app wind angle**, then press **Ent**,
- Select **Auto** then press **Ent**, the following page is displayed:

Calibration app wind angle		
Starboard	Port	Offset
XX°<	---	---
---	---	---
Start:ENT		

- Come to close-hauled starboard tack, and once the boat is stabilized, start recording the apparent wind angle by pressing **Ent**, the following page is displayed:

Calibration app wind angle		
Starboard	Port	Offset
XX°<	---	---
---	---	---
Cancel:PAGE		Stop:ENT

- When you estimate that you have enough correct measurements, press **Ent** to stop recording, then change tack so as to come to close-hauled port tack. The following window is displayed:

Calibration app wind angle		
Starboard	Port	Offset
	>XX°	---
---	---	---
Cancel:PAGE		Stop:ENT

- Start again just like for starboard tack, then press **Ent** to stop recording and display the calculated offset. Perform another starboard tack then another port tack in order to complete the table and refine the calculated offset. Press **Ent**, the following page is displayed:

Record the new offset?	
New offset:	XX°
Old offset:	XX°
Yes	
no	
Cancel: PAGE	Confirm: ENT

- The line **old offset** shows the offset value already present on the apparent wind angle, and the line **New offset** shows the average of the 2 calculated offsets. If you wish to save this new offset, select **Yes** using the browser , then press **Ent**. Otherwise, press **Ent**.

5. INSTALLATION

This chapter describes the installation and initialisation of the **Gyropilot Graphic**. It also describes the complete initialisation of the **Gyropilot**. The general installation of the pilot (cylinder, calculator, angle of rudder, etc.) is described in the **Gyropilot computer** guide.

IMPORTANT :

- Read this guide entirely before starting the installation.
- The electrical connection on the **TOPLINE bus** must be carried out with the terminal box 90-60-417 (equipped with a connection terminal for the NMEA input).
- Only use **TOPLINE** bus cable of the type 20-61-001.
- Any intervention on the **TOPLINE bus** must be carried out with the installation power switched off.

5.1 Packing list

- One **Gyropilot Graphic** equipped with six meters of cable, integrating the **TOPLINE bus** and one **NMEA** input.
- One user guide.
- One protective cover.
- One locking nut.

5.2 List of accessories

- Standard terminal box TOPLINE bus : 90-60-121
- Terminal box TOPLINE bus with NMEA input : 90-60-417
- White protective cover : 31-15-059

5.3 Installation precautions

Before starting the installation, take the time to choose the most appropriate place. The location of the **Gyropilot graphic** must be:

- so that the helmsman can easily operate the control keyboard and read the display,
- placed in a location away from potential shocks,
- more than 40cm away from a magnetic compass,

5.4 Wall mounting

Make sure the location is clean, smooth and flat. Check that there is sufficient space behind the partition to make the cable run.

- Perform the $\varnothing 17$ drillings according to the drawing of figure 2,
- clean the mounting surface with alcohol,
- Lay a thin silicone sealing joint around the mounting perimeter,
- introduce the cable in the $\varnothing 17$ drilled hole,
- position the display then tighten the fixing nut moderately.

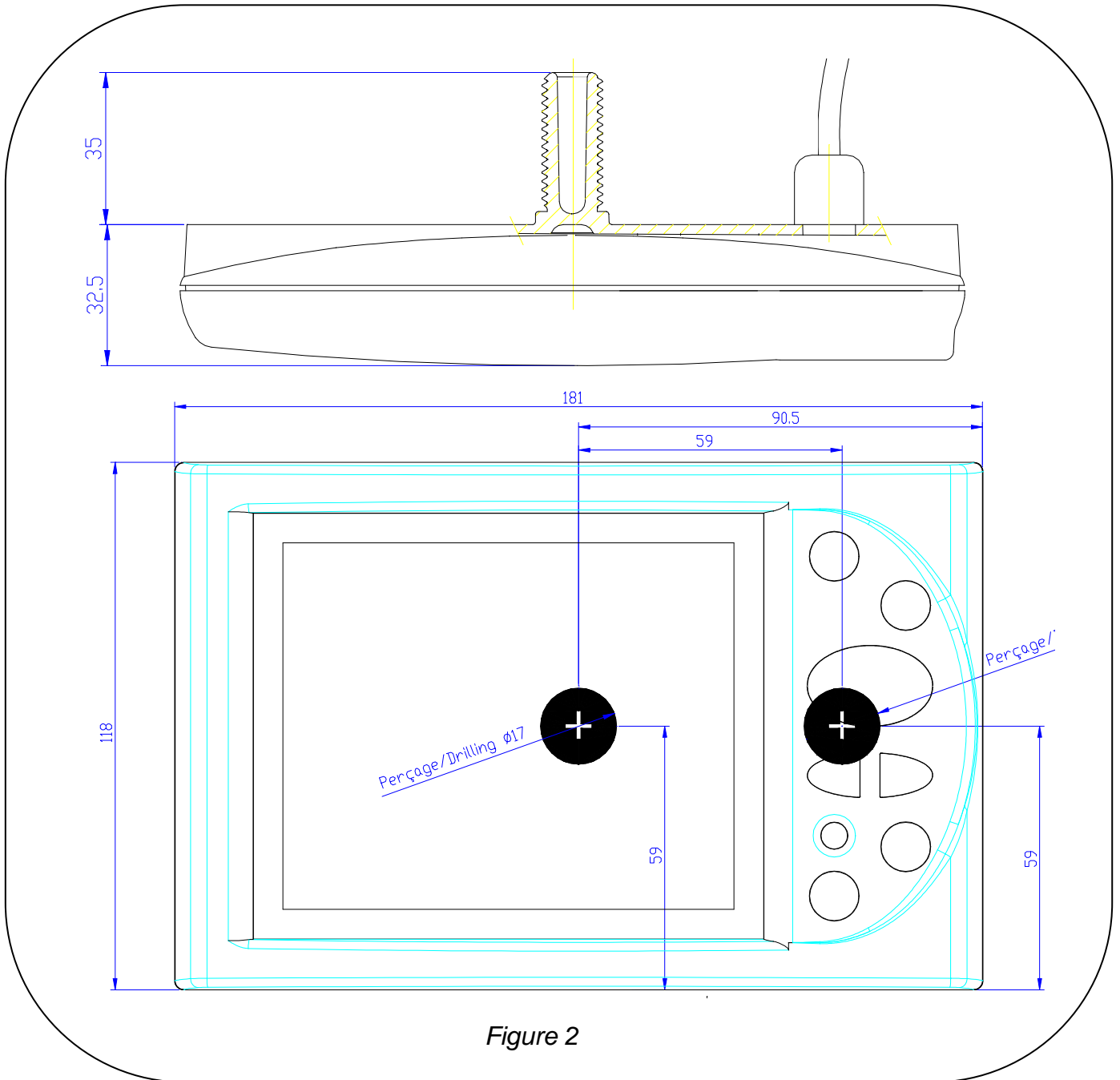

Figure 2

CAUTION :

- When mounting the display, tighten the nut moderately. Excessive tightening can cause the casing to break.
- Do not use glue putty to mount the display.

5.5 Connection to the *Topline bus* and to the NMEA bus

1. Make the bus cable run from the *Gyropilot Graphic* to the *TOPLINE* terminal box of your installation.
2. Connect the bus cable inside the terminal box.

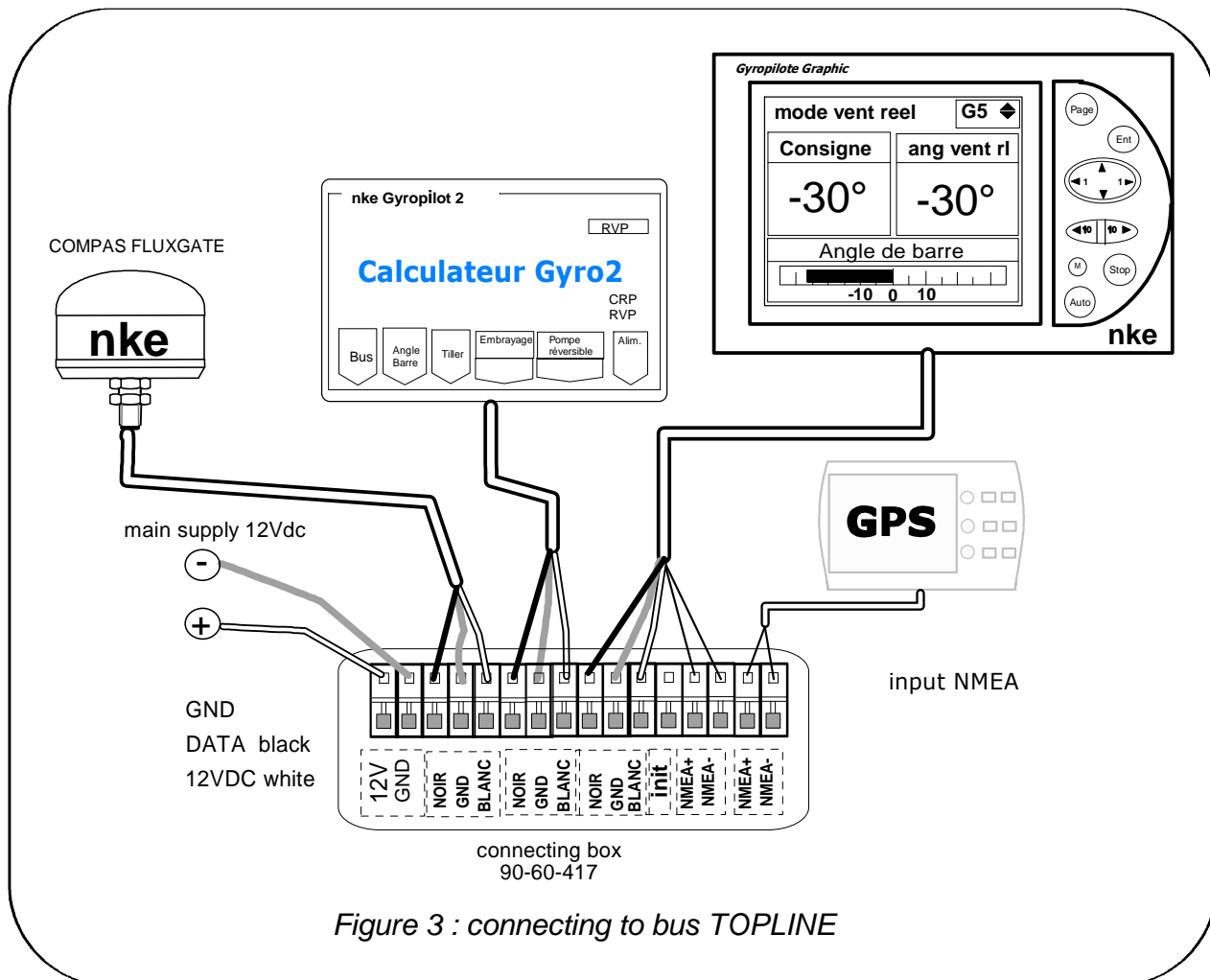

If you reduce the length of the bus cable, strip and galvanise the wires before connecting them inside the terminal box.

Identification of the cable wires

White cable 5 wires	Wires identification	
White wire	+12V	TOPLINE Bus
Black wire	<i>Topline</i> Data	
Braid	Earth	
Red wire	Not connected	
Yellow wire	NMEA +	NMEA input
Green wire	NMEA -	

5.6 Initialisation of the *Gyropilot Graphic*

At first power-up, you must initialise the *Gyropilot Graphic* so that an address is assigned to it. The display is delivered with the address set as **0**. During the initialisation, it will automatically insert itself in the list of instruments of the *TOPLINE bus* of your installation:

- either as master, at the address **1**, if this address is available on the bus,
- or as slave, if the address 1 is taken by a master, at an available address comprised between **2** and **20**.

Please note that if the *Gyropilot Graphic* is not initialised then the following message is displayed: « **Master absent. The Gyropilot has no address, initialise the address of the Gyropilot in the Menu/configuration** ».

Initialisation procedure: the *Gyropilot Graphic* is at the address **0**

- Using the **Page** key, select the **Main menu** page,
- then using the browser , select **Configuration** then **Address initialisation**,
- press the **Ent** key,
- the following message is displayed « *to obtain an address, press the Ent key* », press the **Ent** key,
- the following message is displayed « **creation of slave list** » and the *Gyropilot* acquires an address. The new address of the *Gyropilot* is temporarily displayed on the screen.
- exit this menu by pressing the **Page** key.

Reinitialisation procedure:

You may need to reinitialise the *Gyropilot Graphic*, for example so that a new address is assigned to it :

- Using the **Page** key, select the **Main menu** page,
- then using the browser, select **Configuration** then **Address initialisation**,
- press the **Ent** key,
- the following message is displayed « *to force the address to 0, press the Ent key* », press the **Ent** key,
- the following message is displayed « **address of the Gyropilot : 0** »
- you can now relaunch the initialisation procedure to assign a different address to the *Gyropilot*.

5.7 Initialisation of the pilot installation

After installing the **Gyropilot**, you must initialise the whole of your pilot system. This is required in order to perform the training of the **Gyropilot computer**: position the rudder at the centre, then into limit stop on starboard side and finally into limit stop on port side, so that the computer stores these positions of the rudder. These three rudder positions are essential for the good operation of the drive unit of the pilot.

Follow the menu « **Pilot Initialisation** » of the **Gyropilot Graphic** which will guide you along the procedure.

Procedure

- Using the **Page** key, select the **Main menu** page,
- then using the browser, select **Configuration** then **Pilot initialisation**,
- press the **Ent** key,
- the following message is displayed « *This procedure will erase current settings. Press the **Ent** key to start. Press the **Page** key to exit* », press the **Ent** key,
- the **Gyropilot Graphic** will guide you through the positioning of the rudder : follow the indications :

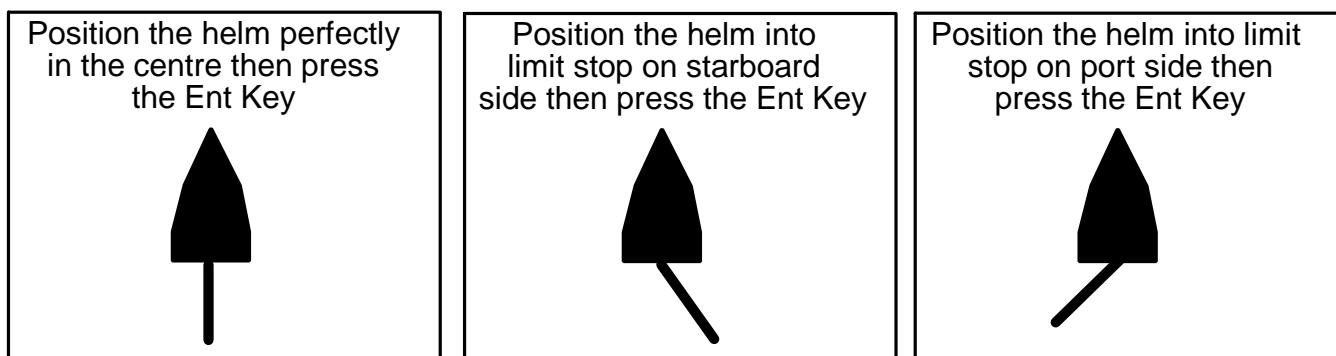

- After performing an auto test, your pilot is initialised,
- Exit this menu by pressing the **Page** key.

CAUTION:

Inadequate initialisation of the pilot can lead to premature wear of the parts, poor heading maintenance by the pilot and excessive electrical consumption.

If you are unsure about your setting, perform the initialisation once again.



NOTES
